

DASH NO.	A	B	C	D
-1	1.27	.31	1.15	.43
-2	1.22	.31	1.22	.31

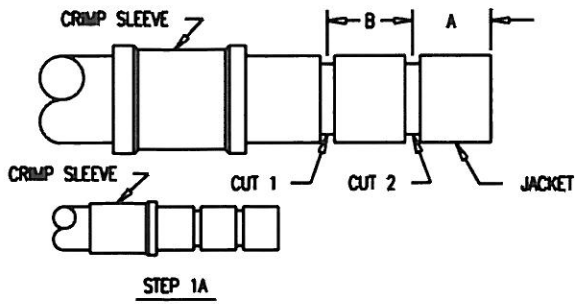

STEP 1

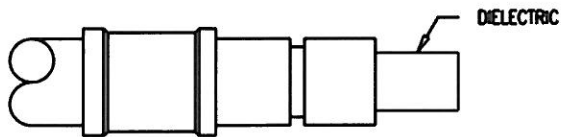

STEP 2

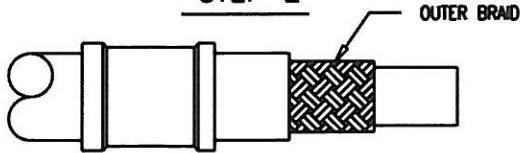

STEP 3

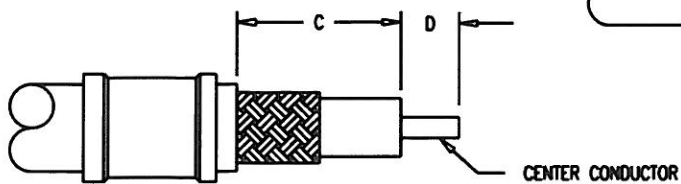

STEP 4

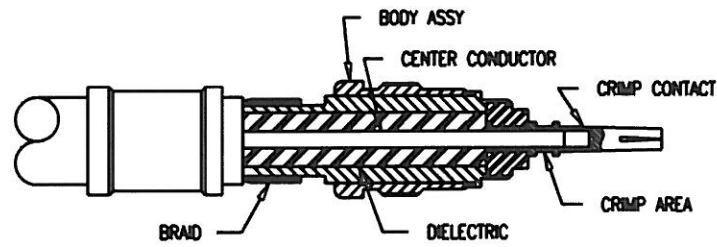

STEP 5

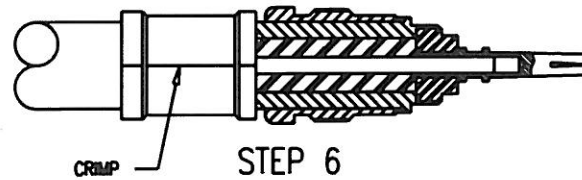

STEP 6

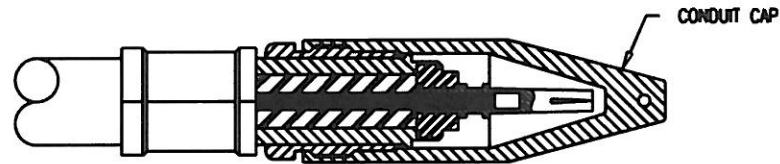

STEP 7

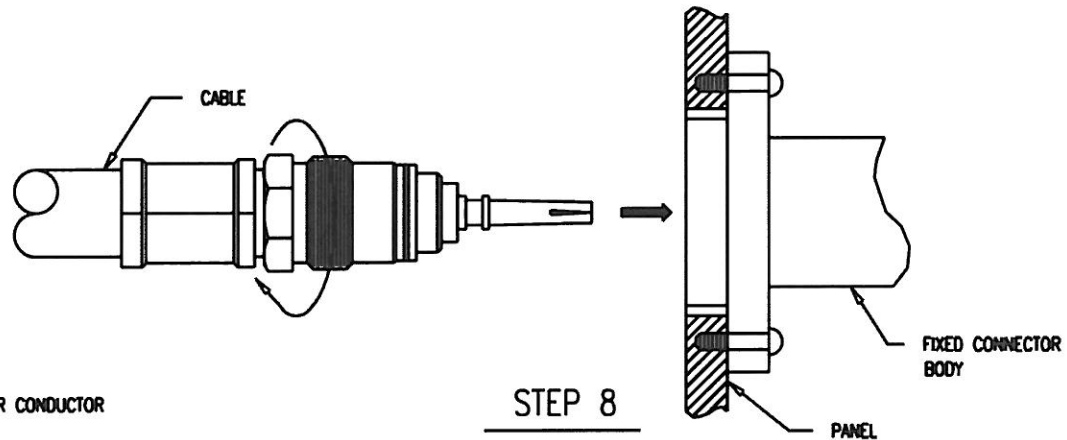

STEP 8

3-601  
(SHEET 1 OF 2)

REVISIONS	
ISSUE	CHANGES
A	ADD -2 PRELIMINARY DWG. JT 10/11/94

WM1837

SCALE
APPROX SURFACE AREA
USED ON K-4926-6
REF.
CABLE INSTRUCTIONS
DRAWN JT DATE 08/04/94
DESIGN DATE
APPR. DATE
<b>KINGS</b> ELECTRONICS CO., INC. TUCKAHOE, NEW YORK 10707
3-601 (SHEET 1 OF 2)

STEP 1

CUT CABLE END SQUARE, SLIDE K-GRIP SLEEVE OVER JACKET. (CAUTION: WHEN USING A SINGLE STEP W/P SLEEVE, SLIDE SMALL END OVER CABLE FIRST AS SHOWN, SEE STEP 1A.) MAKE CUTS 1 AND 2 IN JACKET.

STEP 2

REMOVE JACKET TO DIMENSION "A" . REMOVE ROUND BRAID AND FLAT BRAID AT EDGE OF JACKET. BE SURE ENDS OF FLAT BRAID ARE FLAT AGAINST DIELECTRIC.

STEP 3

REMOVE JACKET TO DIMENSION "B", EXPOSING ROUND BRAID.

STEP 4

TRIM DIELECTRIC TO DIMENSION "C". EXPOSED CENTER CONDUCTOR LENGTH WILL BE EQUAL TO DIMENSION "D".

STEP 5

PUSH THE K-GRIP BODY OVER THE DIELECTRIC AND FLAT BRAID AND UNDER ROUND BRAID UNTIL DIELECTRIC BOTTOMS AGAINST INSULATOR. (ONCE THE FLAT BRAID IS UNDER THE K-GRIP BODY, A CAREFUL ROTATION OF THE DIELECTRIC AND FLAT BRAID WILL EASE ASSEMBLY UNDER THE ROUND BRAID). USING APPROPRIATE CRIMP DIE, CRIMP CENTER CONTACT BETWEEN SHOULDER AND CROSS HOLES.

STEP 6

SLIDE K-GRIP SLEEVE AGAINST SHOULDER ON BODY AND FORM HEX BY CRIMPING.

NOTE: SLEEVE SHOULD NOT BE AGAINST CLAMP NUT BEFORE CRIMPING.

STEP 7

CONDUIT CAP SHOULD BE USED WHEN ROUTING CONNECTOR AND CABLE THROUGH CONDUIT (WHEN APPLICABLE).

STEP 8

THREAD CRIMP ASSEMBLY INTO CONNECTOR BODY AND LOCK SECURELY (60 IN-LBS MAX.).

REVISIONS

ISSUE

CHANGES

A

MOD. STEP 5 PRELIMINARY DWG.  
JT 10/11/94

WJM1836

SCALE 1:1

APPROX SURFACE AREA

WAS: E-18560-6

USED ON

REF:

CABLING INSTRUCTIONS

DRAWN JT DATE 08/04/94

DESIGN DATE

APPR. DATE



ELECTRONICS CO., INC.  
TUCKAHOE, NEW YORK 10707