

# CVB-EX

## Mil-C-5015 reverse bayonet ATEX Connectors



### Standards



#### Certification

94/9/EC (ATEX) Directive

#### According to European Standards

EN 60079-0  
EN 60079-1  
EN 61241-0  
EN 61241-1

Certificate **ICEPI 08 ATEX 03C002X**

-  I M2 Ex d I
-  II 2G Ex d IIC
-  II 2GD Ex d IIC tD A21 IP66/IP67

### Application area

Suitable for **surface applications**  
Group II Zones 1, 21, 2 and 22 (Gas and Dust)

Gas Group **IIC**

Suitable for **underground applications**  
Group I category M2

Can be installed on devices and enclosures  
designed with following type of protection

- |                  |                          |
|------------------|--------------------------|
| Explosion proof  | <b>Ex d – EN60079-1</b>  |
| Increased safety | <b>Ex e – EN60079-7</b>  |
| Intrinsic safety | <b>Ex i – EN60079-11</b> |
| Pressurization   | <b>Ex p – EN60079-2</b>  |



Istituto Certificazione Europea Prodotti Industriali S.p.A.  
organismo notificato n. 0068

Messrs.  
**DYNAMIN S.r.l.**  
P.za Venini, 8  
VITTUONE (MI)

To the att.n of Mr. Carlo Grassi

Piacenza, 10.06.2008

**SUBJECT:** Verification of the conformity to the directive **94/9/EC** of Your **Connectors** series **CVB-Ex** and **CVBM-Ex**, protected by "flameproof enclosure" and by "enclosure tD".

With reference to Your request, we confirm You the conformity of the above mentioned **connectors** to the directive 94/9/EC (ATEX), with the following characteristics:

**Group I cat. M2 - Group II cat. 2GD**  
**Ex d I - Ex d IIC, Ex tD A21 IP66/67**

Reference standards:

**EN 60079-0 EN 60079-1 EN 61241-0 EN EN 61241-1**

The relevant EC-Type Examination Certificate will bear the following number:

**ICEPI 08 ATEX 03C002X**

Regards

**ICEPI S.p.A.**  
ATEX Department  
The Technical Director  
Ponzinibio Claudio

Via Paolo Bellini, 29/31/33 • 29100 Piacenza • Italy  
tel. +39 0523 809585 • fax. +39 0523 691300 • e-mail: info@icepi.com • web site: www.icepi.com



---

## Reverse bayonet coupling system

The reverse bayonet connectors are derived from the threaded Mil-C-5015 series to provide faster coupling and anti-vibration resistance.

In this series the coupling system is composed by 3 bayonet ramps (see drawing below) machined on the external side of the receptacle connector and 3 stainless steel studs mounted inside the plug connector's coupling nut.

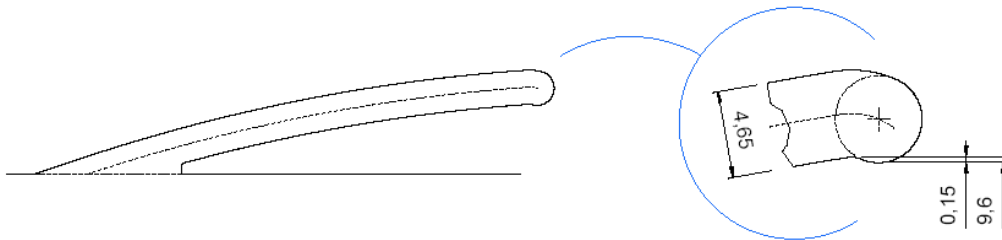

### Characteristic

To mate connectors rotate coupling-nut 120° only  
Audible, visible and tactile mating.

The bayonet ramps are resistant to damage

### Advantages against the thread coupling

*Fast coupling and uncoupling*

*Security of coupling is guaranteed and consequently improved reliability*

*Higher number of mating cycles*

## General Characteristics

- |                           |  |
|---------------------------|--|
| ○ Working Temperature:    | -40°C / +135°C                                       |
| ○ Protection degree:      | IP66/IP67 according to EN 60529                      |
| ○ Shell material:         | Hard anodized aluminium alloy or nickel plated brass |
| ○ Safety lock:            | In threaded stainless steel hexagon socket screw     |
| ○ Available arrangements: | Wide range according to Mil-C-5015                   |
| ○ Shell sizes:            | from 16S to 40                                       |
| ○ Contacts quantity:      | from 2 to 150  |
| ○ Contacts termination:   | Crimp or solder                                      |



## Contacts rating

Contact Size	Pin diameter mm.	Max. operating current (A)
20	1	3
18	1.42	6
16S	1.58	10
16	1.58	10
12	2.38	20
8	3.6	40
4	5.7	63
0	9.05	125

## Available arrangements

5015 arrangements normally available

Arrangement	Tot ct.	AWG contacts size					
		0	4	8	12	16	18
16S-1	7					7	
16S-4	2					2	
16S-5	3					3	
16S-8	5					5	
18-1	10					10	
18-3	2				2		
18-4	4					4	
18-8	8				1	7	
18-9	7				2	5	
18-10	4				4		
18-11	5				5		
18-12	6					6	
18-19	10					10	
18-20	5					5	
18A-5	5					5	
20-3	3				3		
20-4	4				4		
20-7	8					8	
20-11	13					13	
20-15	7				7		
20-18	9				3	6	
20-24	4			2		2	
20-27	14					14	
20-29	17					17	
20-33	11					11	
20A-48	19					19	
20B-8	8				4	4	

Table 1

## Arrangements front view (male insert) by shell size

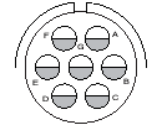
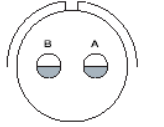
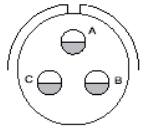
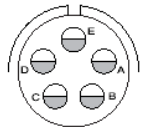
Shell size: <b>16S</b>				
Arrangement	16S-1	16S-4	16S-5	16S-8
Contacts No.	7	2	3	5
Contact size	16	16	16	16

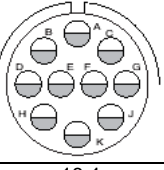
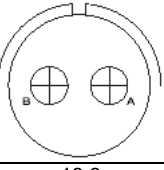
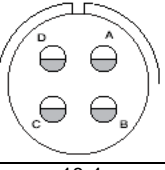
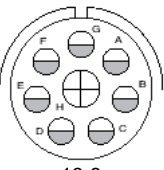
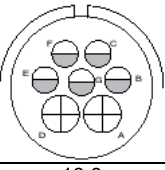
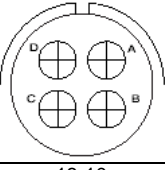
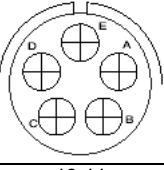
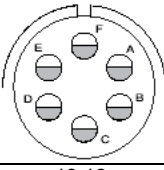
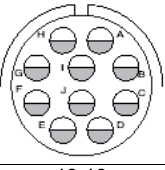
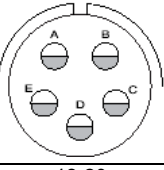
Shell size: <b>18</b>						
Arrangement	18-1	18-3	18-4	18-8	18-9	18-10
No. of contacts	10	2	4	8	7	4
Contact size	16	12	16	7/16 + 1/12	5/16 + 2/12	12
						
Arrangement	18-11	18-12	18-19	18-20		
No. of contacts	5	6	10	5		
Contact size	12	16	16	16		

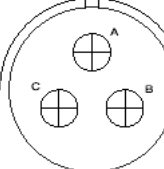
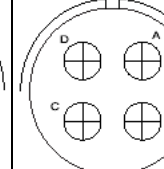
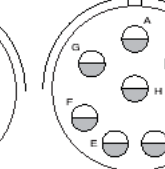
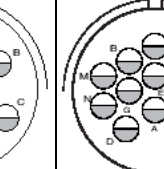
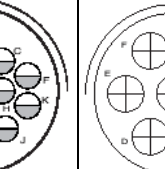
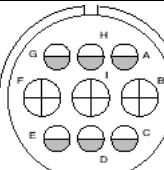
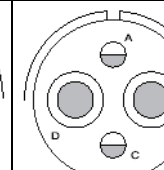
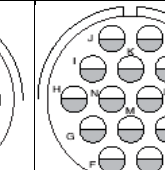
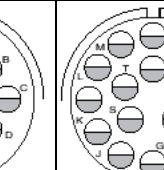
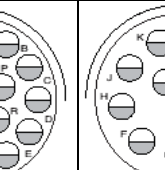
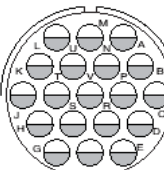
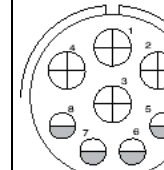
Shell size: <b>20</b>					
Arrangement	20-3	20-4	20-7	20-11	20-15
No. of contacts	3	4	8	13	7
Contact size	12	12	16	16	12
					
Arrangement	20-18	20-24	20-27	20-29	20-33
No. of contacts	9	4	14	13	11
Contact size	6/16 + 3/12	2/16 + 2/8	16	16	16
					
Arrangement	20A48	20B8			
No. of contacts	19	8			
Contact size	16	4/16 + 4/12			

## Connector shells

### CVB-EX G-H-K-M-N

CVB-EX G-H-K-M-N-P shells can be screwed indirectly to the equipment enclosure or fixed into a wall trough a nut.

Provided with metric thread

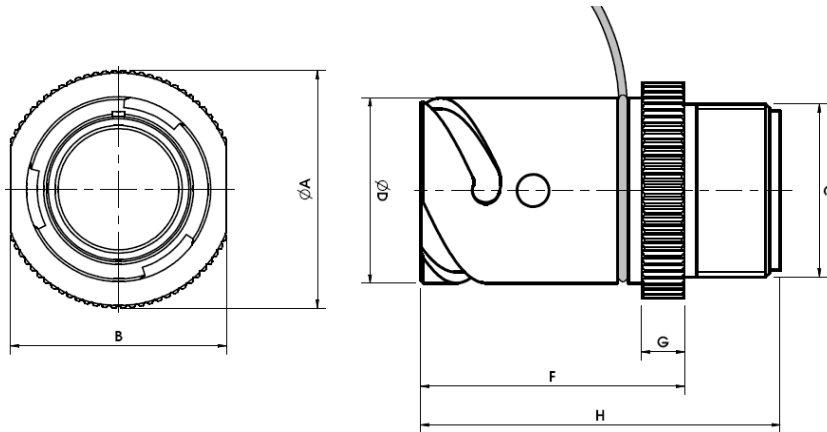

Size	A	B	L	D	F	G	H
16S	37	32	3.1	27.4	40.6	6.5	53.8
18	40	34	3.1	30.8	45.1	8	66.8
20	44	40	3.1	34.2	45.1	8	66.8

### C thread

Size	G ISO 228	H R ISO 7/1	K Gk UNI 6125	M ISO 261	N NPT ASA B2.1
16S	G 3/4"	Rc 3/4"	Gk 3/4"	M 25	3/4"
18	G 3/4"	Rc 3/4"	Gk 3/4"	M 28	3/4"
20	G 1"	Rc 1"	Gk 1"	M 32	1"

## CVB-EX 1

CVB-EX 1 - when used as inline receptacle requires a back shell.  
 Provided UNEF thread

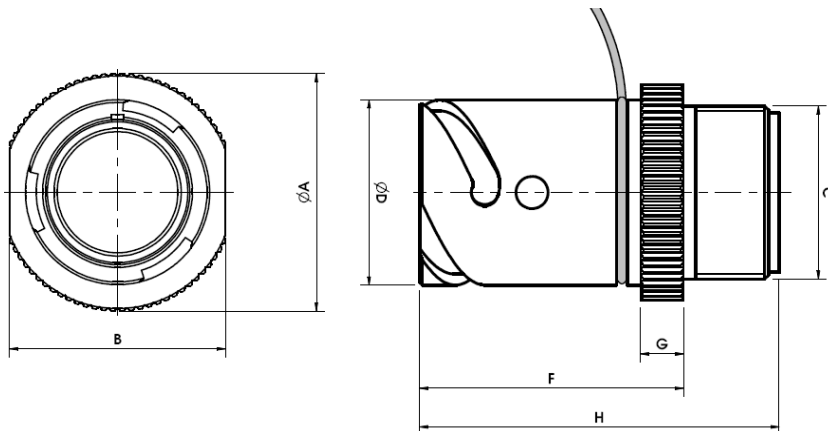

Size	A	B	C	L	D	F	G	H
16S	37	32	7/8"-20 UNEF-2A	3.1	27.4	40.6	6.5	53.8
18	40	34	1"-20 UNEF-2A	3.1	30.8	45.1	8	66.8
20	44	40	1/8-18 UNEF-2A	3.1	34.2	45.1	8	66.8

**CVB-EX 2**  
 Flange mounted receptacle  
 Cylindrical terminal

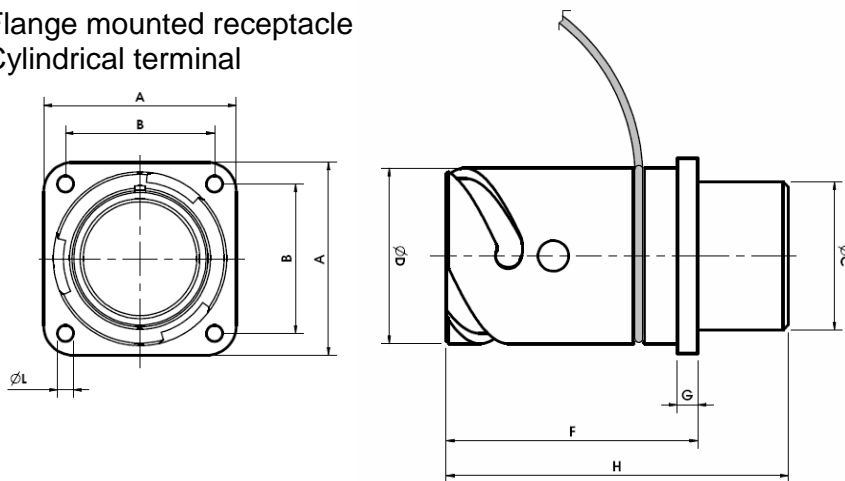

Size	A	B	C	L	D	F	G	H
16S	32.5	24.6	22.4	3.1	27.4		3.2	
18	34.9	27	25.6	3.1	30.8	45.1	4	63.1
20	38.1	29.4	28.8	3.1	34.2	45.1	4	63.1

---

## CVB-EX 6

Inline Plug

It always requires a back shell

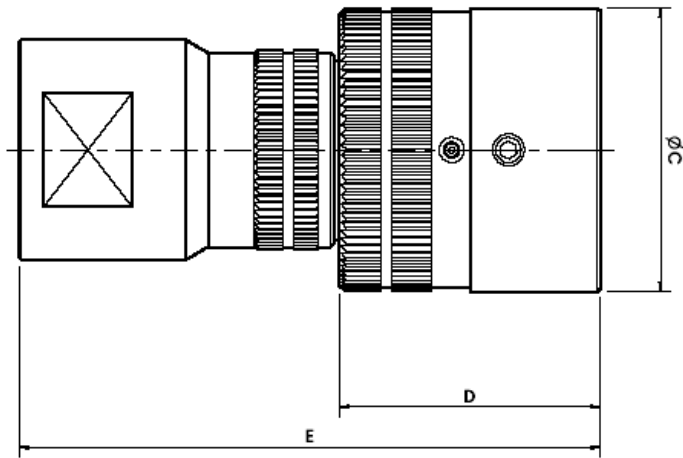

SIZE	C	D	E
16S	38	33.5	
18	41.6	41.5	
20	45	41.5	

E dimension depends on back shell version



**Caps  
TVB-1**

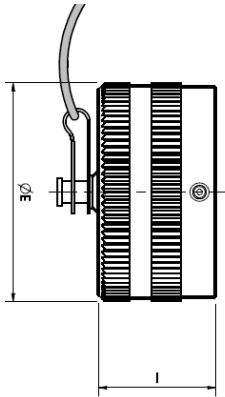

Size	E	I
16s	33	16
18	38	21.7
20	40.5	21.7

**TVB-6**

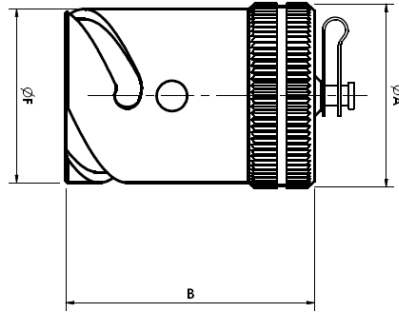

Size	A	B	F
16s	29.8	43.2	27.4
18	33	50.2	30.8
20	36.5	5.02	34.2

**TVB-Ex 1**

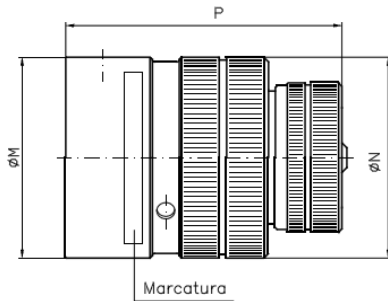

Size	M	N	P
16s	38	38	48
18	41.6	41.6	58
20	45	45	58

**TVB-Ex-6**

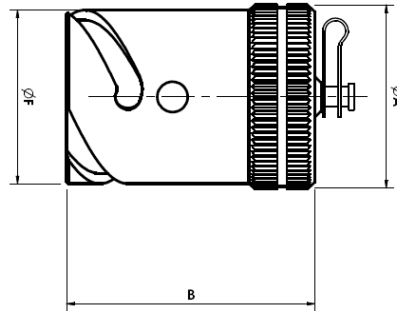

Size	A	B	F
16s	29.8	43.2	27.4
18	33	50.2	30.8
20	36.5	5.02	34.2

## Connectors P/N explanation

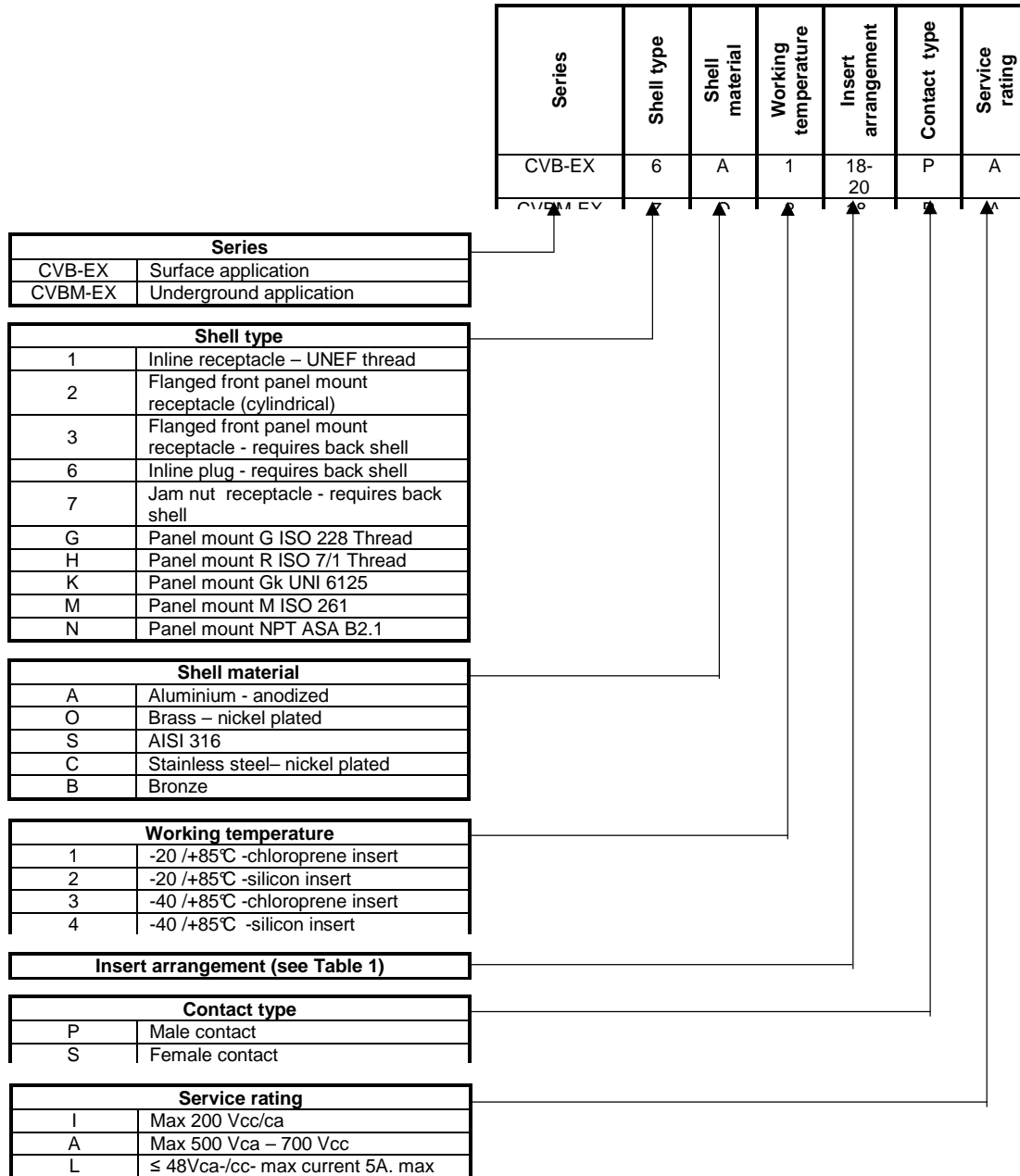

## Back shell P/N explanation

Plugs and some types of receptacle are supplied with back shell.

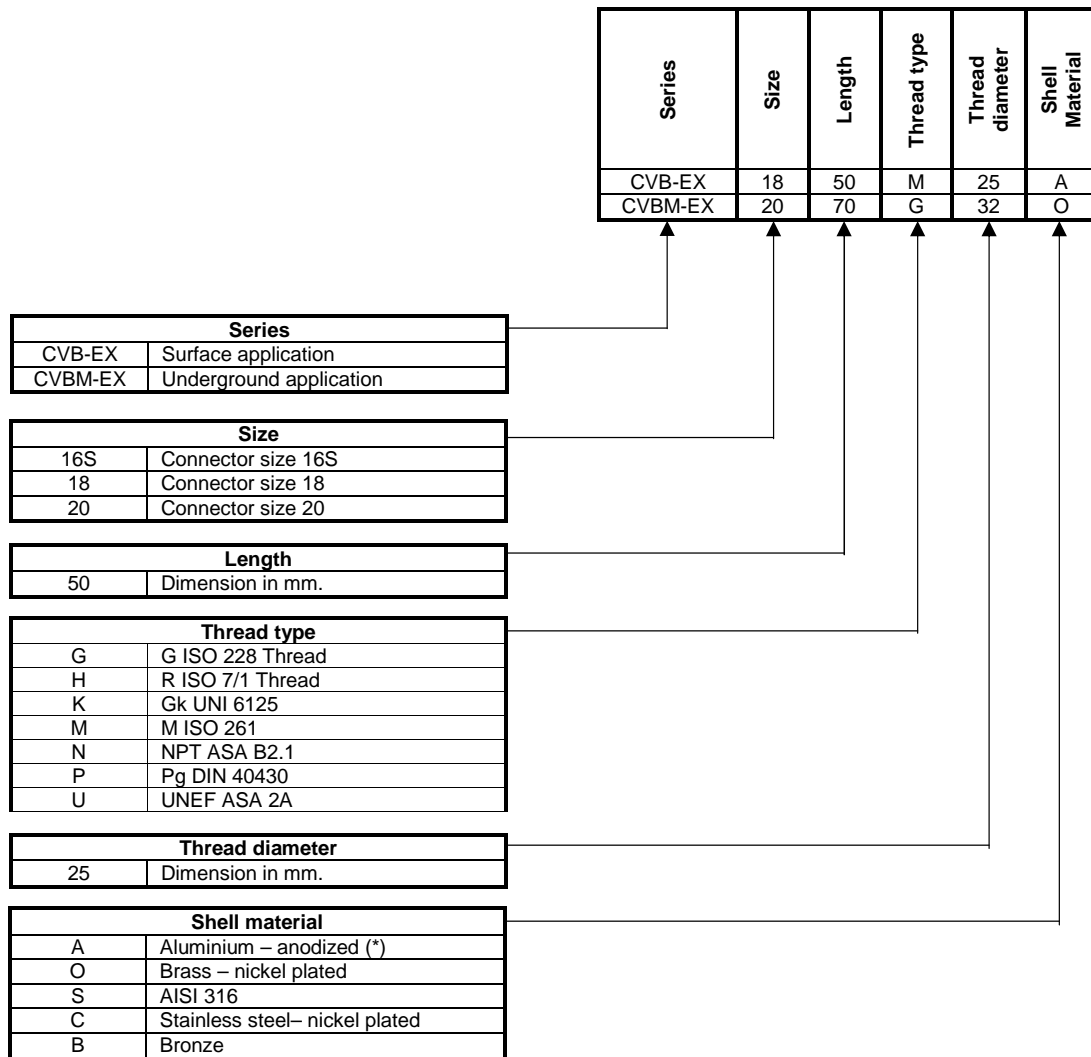

(\*) Not for CVBM

## Caps P/N explanation

CVB-EX normally requires caps.

Two caps versions are available:

- simple protection
- explosion proof

Series	EX	Type	Material	Working Temperature	Size	Arrangement	Pilot contacts	Modification code
TVB	-EX	1	A	1	16S	-1		
TVBM	-EX	6	O	2	20	-33	C	

Series	
TVB	Surface application
TVBM	Underground application

EX	
-	Standard cap
-EX	ATEX cap

Type	
1	For receptacles
6	For plugs

Material	
A	Aluminium – anodized (*)
O	Brass – nickel plated
S	AISI 316
C	Stainless steel– nickel plated
B	Bronze

(\*) Not for TVBM

Working temperature (-EX only)	
0	-40 /+135°C (**)
1	-20 /+135°C (chloroprene)
4	-40 /+135°C (silicon)

(\*\*) Referred to version w/out pilot circuit – silicon gasket

Size	
16S	For connector size 16S
18	For connector size 18
20	For connector size 20

Connector's arrangement (see Table 1)	

Pilot circuit (-EX only)	
S	Absent
B	Pin contacts
C	Socket contacts
D	Pin contacts and diode
E	Socket contacts and diode

Modification as specification codes	
-	Absent



## Additional Clements National Industry Specific Catalogs

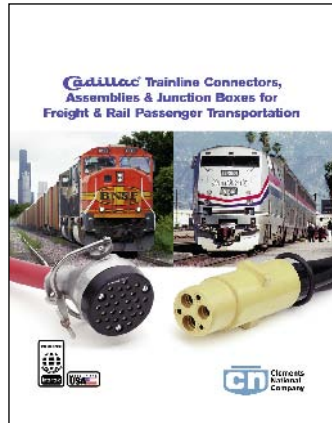

Power & Control Connectors, Cable Assemblies & Junction Boxes for the Freight & Rail Passenger Industry.

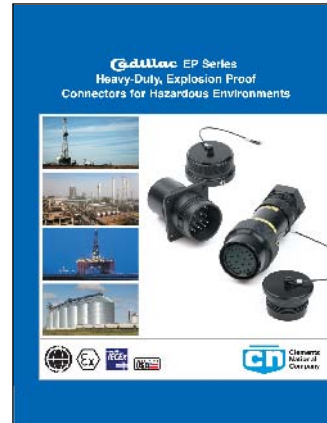

EP Series Heavy-Duty, Explosion Proof Connectors for Hazardous Environments, including Marine, Oil & Gas, and Grain Silos.

### Clements National Sales Offices:

Dennis Carlson  
**Clements National Company**  
2150 Parkes Drive  
Broadview, Illinois 60155  
Tel: 708-594-5890 x 218  
Fax: 708-594-2481  
E-Mail: [dns Carlson@winchesterelectronics.com](mailto:dns Carlson@winchesterelectronics.com)

Steve Riddell  
**Clements National Company**  
672 Ramsgate Rd.  
Burlington, Ontario L7N 273  
Canada  
Tel: 905-464-1268  
Fax: 905-681-0182  
E-Mail: [sriddell@winchesterelectronics.com](mailto:sriddell@winchesterelectronics.com)

Andrea Nehrbass  
**Clements National Company**  
2150 Parkes Drive  
Broadview, Illinois 60155  
Tel: 708-594-5890 x 234  
Fax: 708-594-2481  
E-Mail: [a.nehrbass@winchesterelectronics.com](mailto:a.nehrbass@winchesterelectronics.com)

Michael Carroccia  
**MEC Sales**  
266 South Road.  
Farmington, CT 06032  
Tel : 860-676-1308  
Fax: 860-676-1492  
Mobile: 860-614-4401  
E-mail: [carroccia@sbcglobal.net](mailto:carroccia@sbcglobal.net)

---

An Authorized Distributor of Van Systems Connectors



Specifications subject to change without notice.

© Clements National Company 2014

**Gadillac** is a Registered Trademark of Clements National Company.

October 2014

2150 Parkes Drive, Broadview, Illinois 60155 USA  
Toll Free: 1-800-966-0016  
Direct/International: 708-594-5890 • Fax: 708-594-2481  
[www.winchesterelectronics.com](http://www.winchesterelectronics.com) • [www.clementsnational.com](http://www.clementsnational.com)