

Table Of Contents

	Description	Page
Overview		
	A Modular High Density Pin and Socket Interconnection System	2
HS Series		
	Daughtercard Socket Connector	4
	Daughtercard Socket Module	6
	Daughtercard Accessories / Ordering Information	8
	Daughtercard Hole Patterns	11
HP Series		
	Backpanel Pin Module	12
	Backpanel Accessories ■ Power Distribution	17
	Backpanel Accessories — Guide Pins	19
	Right Angle HD+® Pin Connector	20
	Backpanel Hole Patterns / Polarization	25
Specifications		
	High Density Plus Specifications and Operating Characteristics	26
Technical Information		
	Signal Integrity of the High Density Plus Family	28
	Compliant Contact	29
	Litton Electronic System Packaging	31
	Other Product Offerings	32

While the information in this publication is believed to be accurate and reliable, all data presented is subject to change without notice. Winchester Electronics disclaims responsibility for any damages resulting from application or any incompleteness or inaccuracies in the information presented. Consult factory for specific information on the latest design specifications.

The following trademarks are owned or licensed by Winchester Electronics:

HIGH DENSITY PLUS®, **HD+®**, **C-Press®**, **HIGH DENSITY PLUS 1™**,
HIGH DENSITY PLUS 2™, **HD+ 1™**, **HD+ 2™**, **HD PLUS 1™**, **HD PLUS 2™**

CSA Certified File No.  LR34182

Recognized under the Component Program of Underwriters Laboratories Inc. File No. E31650 

Overview

A Modular High Density Pin and Socket Interconnection System

- Complete system design enhances product performance and reduces time-to market
- Modular backplane and daughter-board connectors offer unlimited design flexibility
- Integral daughterboard stiffener
- Optional **HD+1™** and **HD+2™** rows of contacts provide additional grounding and shielding without sacrificing signal contact density
- Higher interconnect density. Up to six rows of contacts on continuous 0.100" grid. Up to 50% greater contact density
- Industry keying / polarization standard
- Integral power management for high current, multi-voltage applications
- **C-Press®** — the most reliable compliant pin in the industry meets 40 year life telecommunications standards
- Two options for the modular power distribution:
 - External Bus Bars
 - Internal Heavy Copper Multilayer Technology
- Meets performance requirements of MIL-C-28859 and MIL-STD-2166
- Contact Sequencing Options

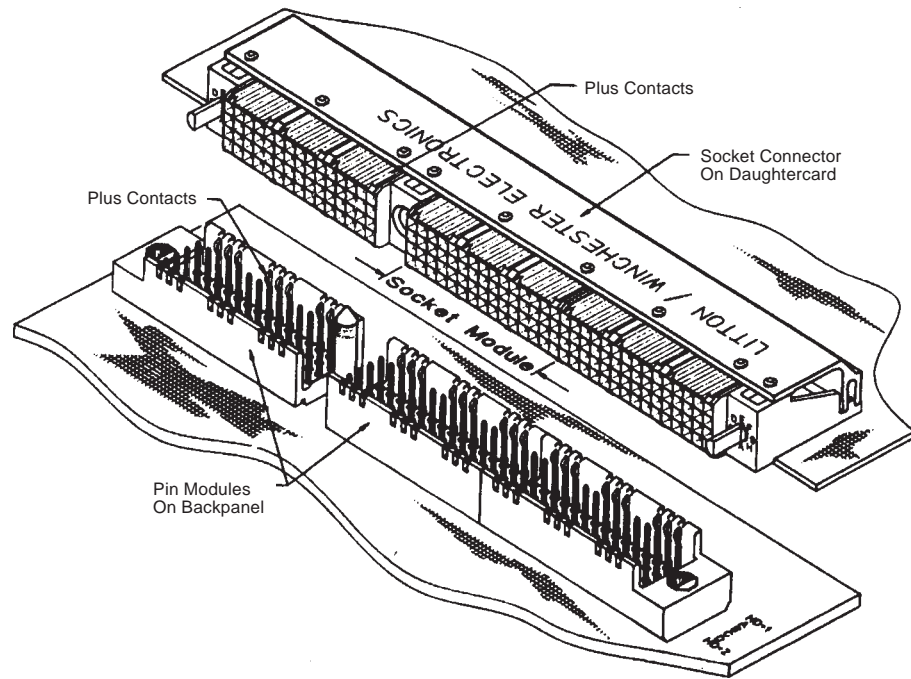

Evolution and Revolution

Using higher speed and higher power semiconductors, today's electronic systems combine many functions into one totally integrated package. These systems must operate faster, more efficiently and be more cost-effective to produce.

Meeting these performance parameters demands that designers must:

1. Minimize reflections due to impedance mismatch.
2. Reduce crosstalk between adjacent signal contacts.
3. Minimize inductance of contacts used for power and ground.
4. Integrate power distribution into the backpanel design.

Don't Conform . . . Create!

HIGH DENSITY PLUS® — a fully integrated interconnection system, is specifically designed to meet existing and anticipated semiconductor technology needs.

Modularity

HD+® combines a modular design concept with the density and electro-mechanical performance vital to VLSI designs.

Both pin and socket modules are end stackable providing a virtually continuous .100 x .100, (2.54 x 2.54) contact grid.

Pin modules are available with both ends open for continuous stacking, with one end wall and with one end polarized to ensure a unique identity.

HD+® incorporates a product family of off-the-shelf back plane and daughtercard connectors including:

3 row modules and 4 row modules, including the **HD+1™** and **HD+2™** contacts illustrated on the next page, address grounding and power requirements, without increasing the size of the connector envelope.

CSA Certified File No.  LR34182

Recognized under the Component Program of Underwriters Laboratories Inc. File No. E31650 

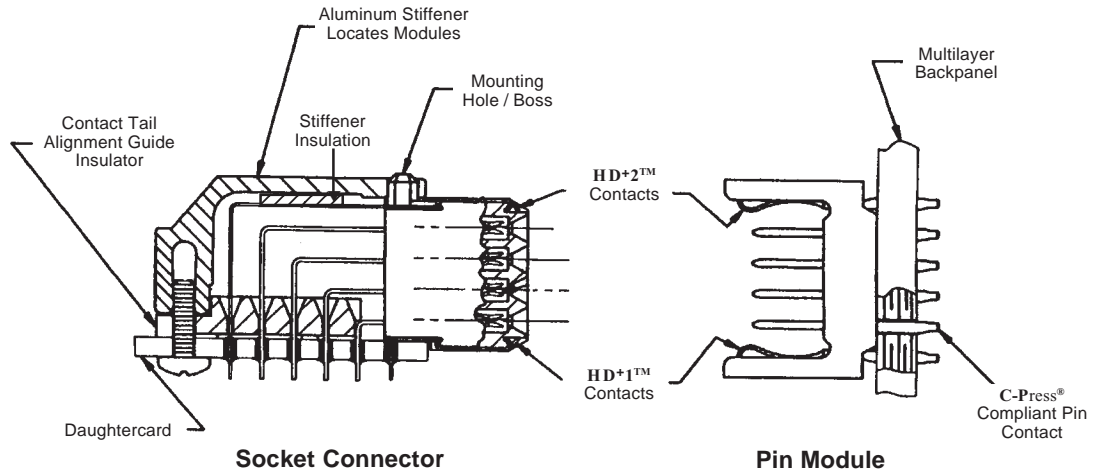

Density

To demonstrate the density achievable with **HIGH DENSITY PLUS®**, a good comparison can be made using the Double Eurocard Format, a standard for VME Bus and Multibus II designs.

192 I/O's are provided using Din 41612 connectors.

Without addressing power, grounding and impedance matching requirements, conventional 4 row, high density connectors can increase this number up to 344 I/O's. With the

addition of the **HD+1™** and **HD+2™** contacts, grounding and impedance matching requirements can be addressed without sacrificing signal contact density.

Power and Ground Capability

Today's designs often require the ability to install and remove daughtercards while the system is operating. To facilitate this, **HIGH DENSITY PLUS®** provides 3 distinct levels of contact sequencing for ground, power and signal.

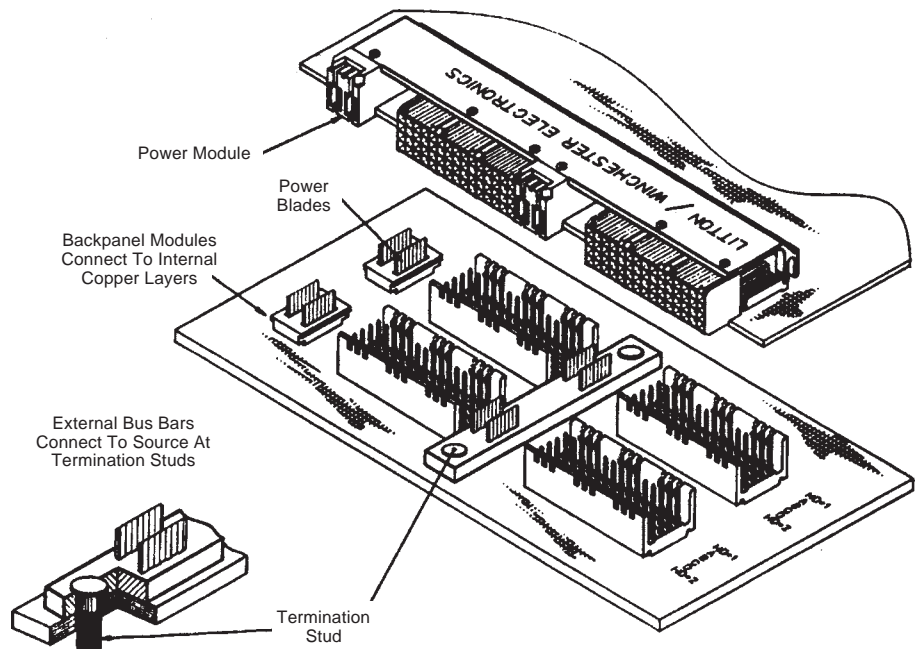

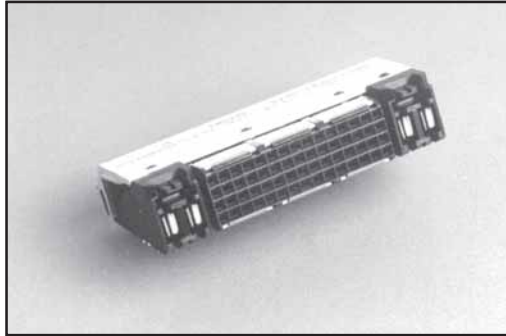

Daughtercard Modules

Socket modules are pre-assembled into precisely located holes in an extruded aluminum stiffener. End-stackability offers the same flexibility to the daughtercard assembly as the backpanel modules. Both are available in 3 and 4 row versions, with each offering 15 or 20 positions per row to mate with the corresponding pin modules.

The **HD+1™** and **HD+2™** contacts of the socket module are located on the bottom and top surfaces of the insulator. These wide conductors mate with Plus row cantilever contacts positioned in the backpanel modules. An extended socket module wipe option is available — refer to sequence of mating chart on page 15.

Guide Modules

As connectors become longer, the mechanics of alignment, insertion forces, and length become more important.

To insure proper alignment, the **HIGH DENSITY PLUS®** system offers a daughtercard module and a mating backpanel guide pin.

Polarization Modules

HIGH DENSITY PLUS® offers polarization modules for unique identity. Stainless steel polarizing keys and bushings used in the modules conform to MIL-C-55302. The configurations are octagonal to provide up to sixty-four polarization options when two modules are used per daughtercard. When polarization modules are used, a guide pin must also be used.

Power and Ground Modules

The **HIGH DENSITY PLUS®** connector system provides daughtercard modules that interconnect to discrete backpanel power modules or an external busing system. Power modules contain two contacts, each rated 20 amperes. This power busing system is designed to distribute power and ground across the backpanel and to the individual daughtercards.

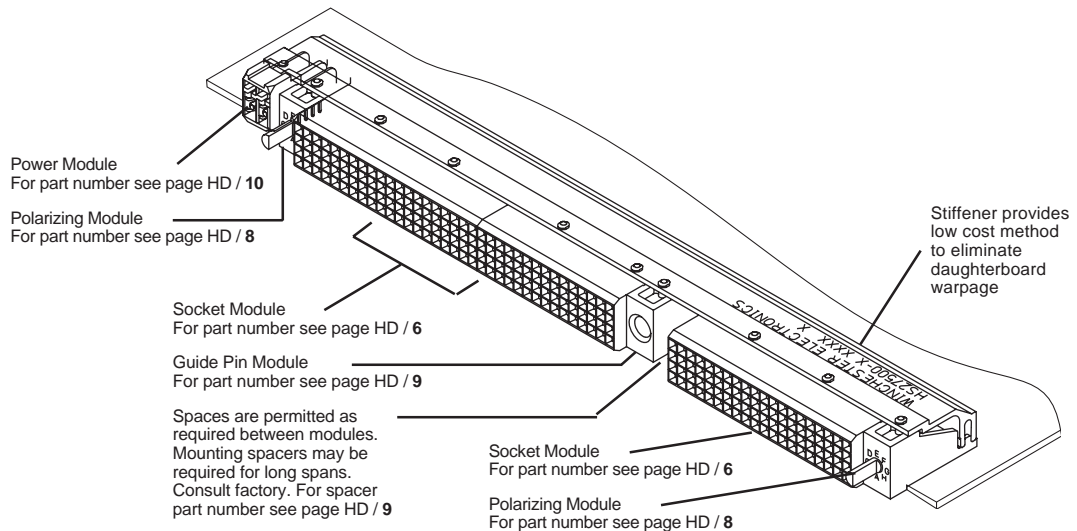

Catalog No. HS27500-X Shown

The final socket connector assembly will be assigned a dash number by the factory

The socket modules and accessories shown on the following pages afford a wide degree of design flexibility. The example shown illustrates how to combine various modules on a stiffener to produce a complete connector assembly.

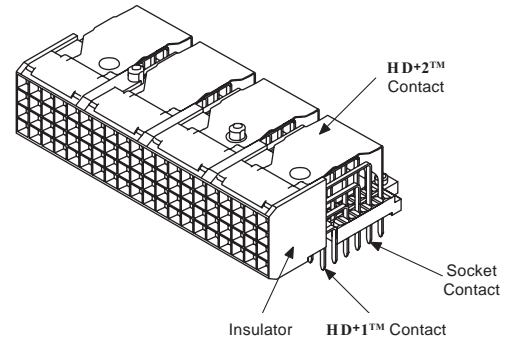
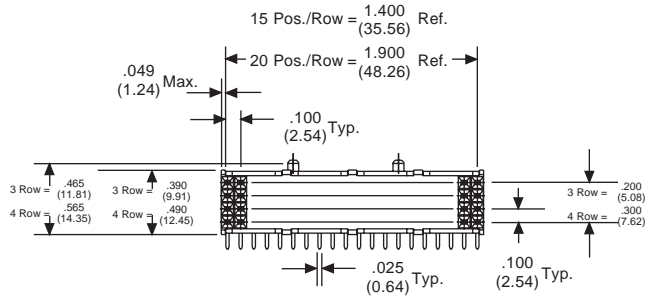
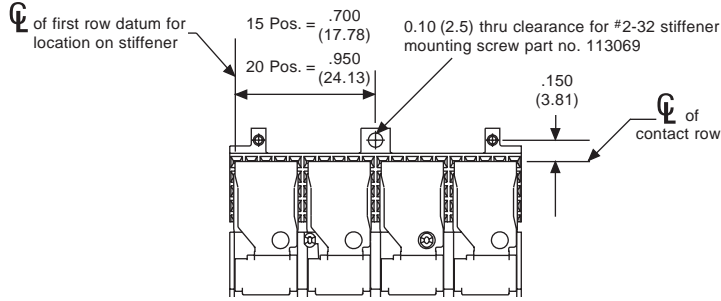

Tail Alignment Guide

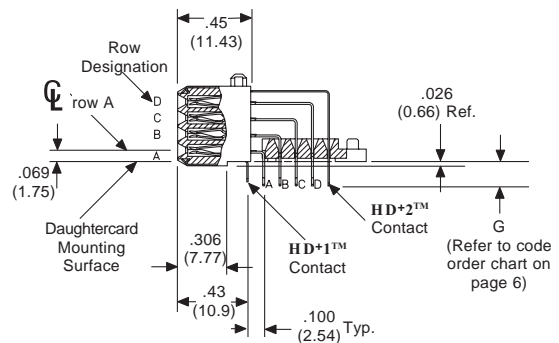

Key Attributes of the High Density Plus System

- Complete system design enhances product performance and reduces time-to-market
- C-Press® meets 40-year life telecommunications standards
- Modular backplane and daughterboard connectors offer unlimited design flexibility
- Integral daughterboard stiffener
- Higher interconnect density. Up to six row of contacts on continuous 0.100" grid. Up to 50% greater contact density
- Industry keying/polarization standard
- Integral power management for high current, multi-voltage applications
- C-Press® — the most reliable compliant pin in the industry
- Two options for modular power distribution:
 - External Bus Bars
 - Internal heavy Copper Multilayer Technology
- Meets performance requirements of MIL-C-28859 and MIL-STD-2166
- Contact Sequencing Options

ORDERING INFORMATION

Note: The following information is used to help the user select individual modules. However, HD+® socket connectors are supplied assembled from individual socket modules. Consult factory for final assembly part number

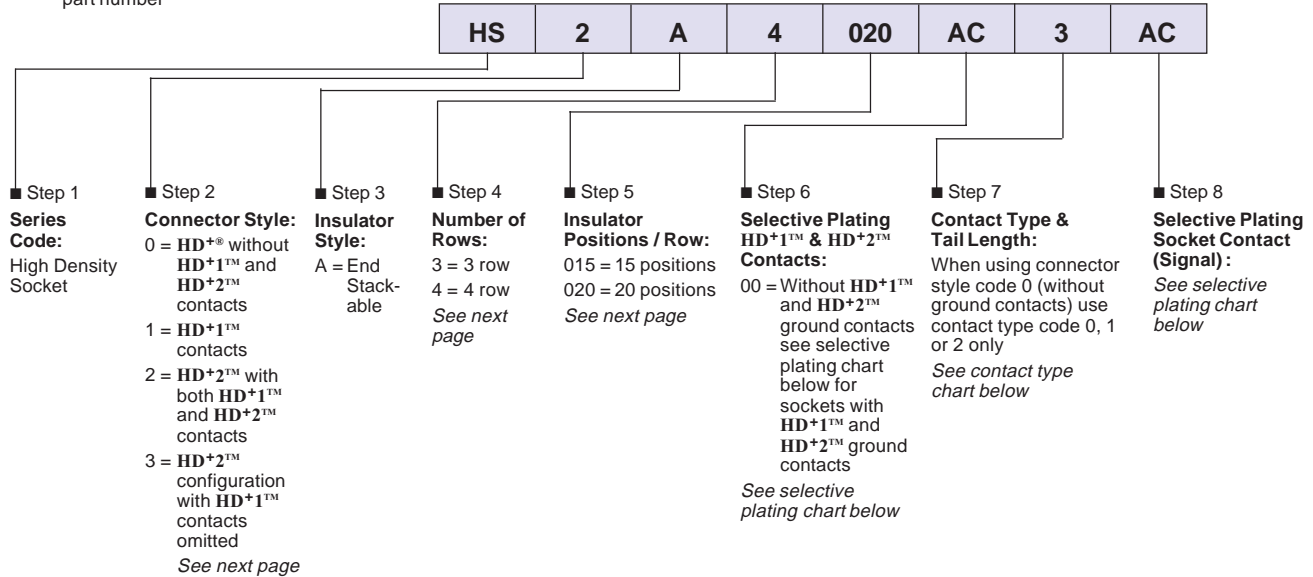

Selective Plating Chart — Step 6 & 8

Code	Mating Area	Solder Tail
AC	.000030 min. Gold	.000100 min. Tin - Lead
GC	.000050 min. Gold	.000100 min. Tin - Lead
BC	Gold Flash over .000025 min. Palladium Nickel	.000100 min. Tin - Lead
BK	Gold Flash over .000040 min. Palladium Nickel	.000100 min. Tin - Lead

Note: Contact underplate is .000050 minimum Nickel

Contact Type Chart — Step 7

P.C.B. Thickness	Code	Socket Contact Description	HD+1™ & HD+2™ Contact Description	G + ^{.015} (0.38) - ^(0.25)
.062 (1.57)	0	Standard Wipe	Standard Wipe	.125 (3.18)
	1	* Extended Wipe	Standard Wipe	
.093 (2.36)	2	Standard Wipe	Standard Wipe	.150 (3.81)
	3	Standard Wipe	* Extended Wipe	
.062 (1.57)	4	* Extended Wipe	* Extended Wipe	.125 (3.18)
	5	Standard Wipe	* Extended Wipe	
.093 (2.36)	5	Standard Wipe	* Extended Wipe	.150 (3.81)

* The Extended Wipe option produces a .025 (0.64 ref.) increase in wipe over the standard socket assembly.

COMPONENTS

Socket Connector Style — Step 2 (4 Row Socket Modules Shown)

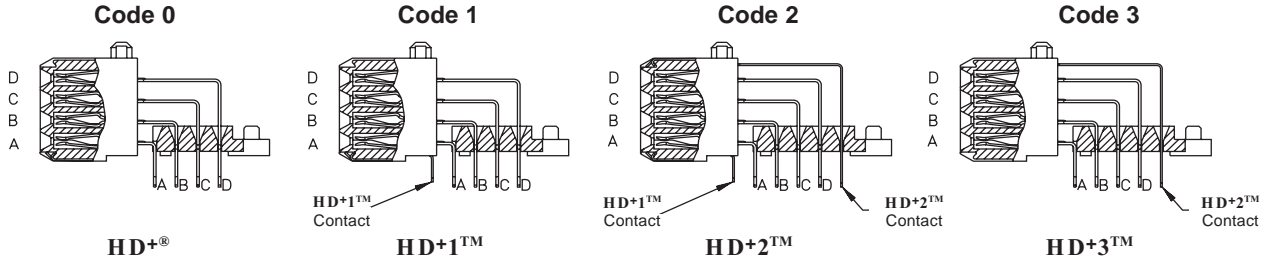

Number Of Rows — Step 4

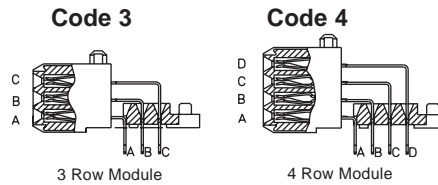

Typical Socket Connector Profile — Step 5

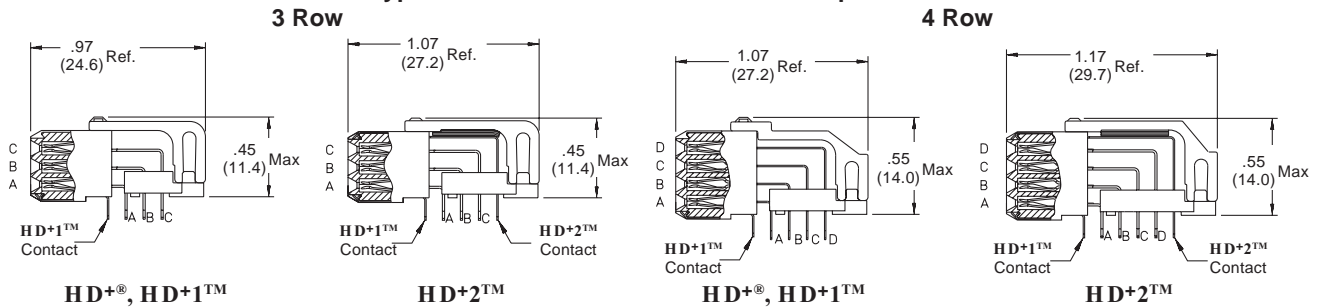

Typical Final Socket Connector Assembled To P.C. Board

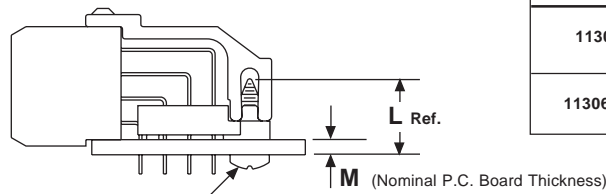

Part Number	L	M
113069	.312 7.92	.031 to .093 0.79 to 2.36
113069 - 1	.375 9.53	.094 to .166 2.38 to 4.22

#2-32 type AB self-tapping thread stiffener mounting screw. Cross recessed pan head.
Material: Stainless steel

One mounting screw is typically supplied for each module or mounting spacer. When using multiple combinations of power, polarizing and guide pin modules, each designated mounting

hole position need not be drilled in the P.C. Board, providing the distance between mounting holes is not greater than two inches.

Polarizing Key

Polarizing key part number **113036** is either supplied loose, not installed or assembled with module. See code order chart

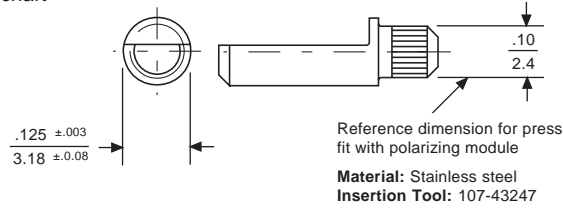

Polarizing Module

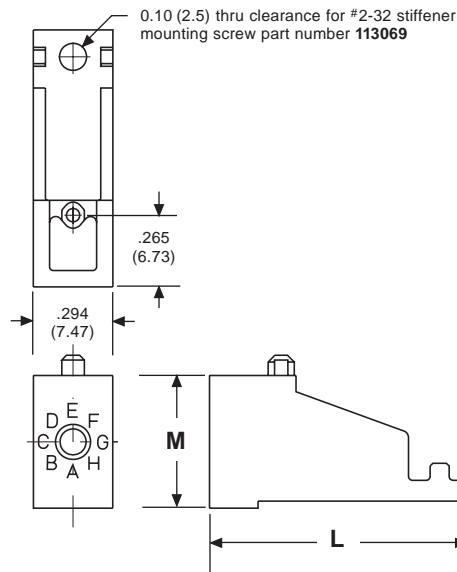

Polarizing Module Assembly

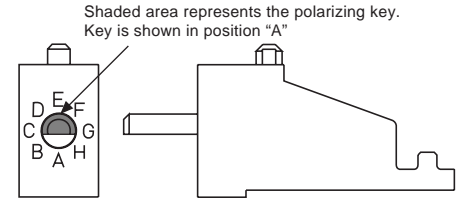

Part number **113038-3A** shown. Code letter indicates the position of flat.

Code Order Chart

A guide pin receptacle module is required on applications using polarizing module.

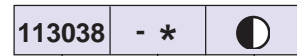

- Step 1: Polarizing Module Part Number
- Step 2: Module Style
- Step 3: Polarizing Style (Omit if polarizing key is not assembled)

Code	Description	Polarization Style			
		Code	Clocking Position	Code	Clocking Position
1	HD+2™, 4 row	A		E	
2	HD+®, HD+1™, 3 row	B		F	
3	HD+®, HD+1™, 4 row	C		G	
4	HD+2™, 3 row	D		H	

Part Number	Description	L	M
113038 - 1	HD+2™, 4 row	1.04 (26.4)	.490 (12.45)
113038 - 2	HD+®, HD+1™, 3 row	.84 (21.3)	.390 (9.91)
113038 - 3	HD+®, HD+1™, 4 row	.94 (23.9)	.490 (12.45)
113038 - 4	HD+2™, 3 row	.94 (23.9)	.390 (9.91)

Guide Pin Receptacle Module

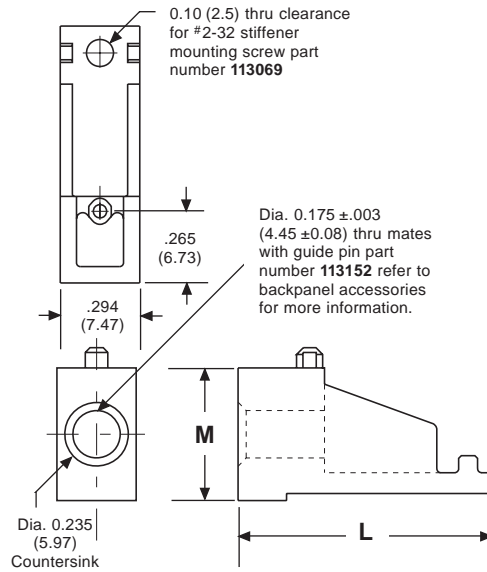

Part Number	Description	L	M
113038 - 5	HD+2™, 4 row	1.04 (26.4)	.490 (12.45)
113038 - 6	HD+®, HD+1™, 3 row	.84 (21.3)	.390 (9.91)
113038 - 7	HD+®, HD+1™, 4 row	.94 (23.9)	.490 (12.45)
113038 - 8	HD+2™, 3 row	.94 (23.9)	.390 (9.91)
113172 - 1	*HD+®, HD+1™, 4 row	.94 (23.9)	.490 (12.45)

* Special heavy duty version with aluminum insert plus screw and lockwasher attachment to stiffener.

Mounting Spacer

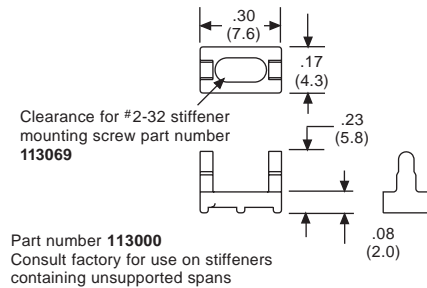

20 Amp Power Module

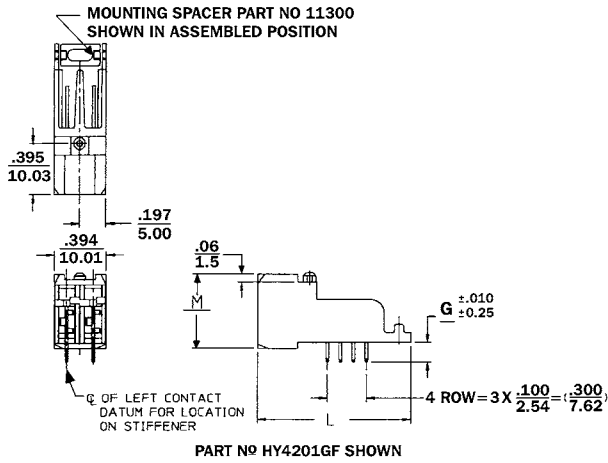

30 Amp Power Module

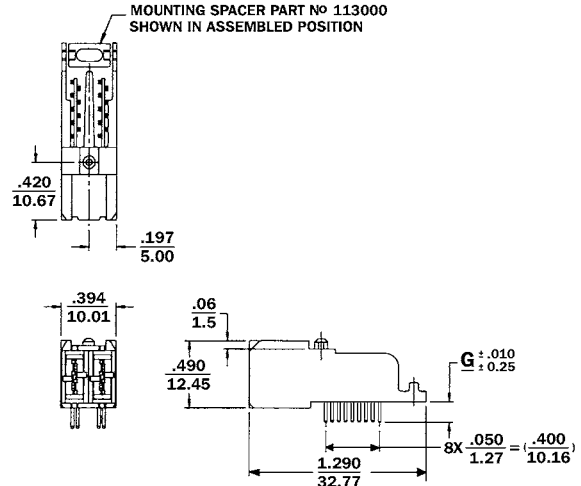

Recommended P.C. Board Hole Patterns

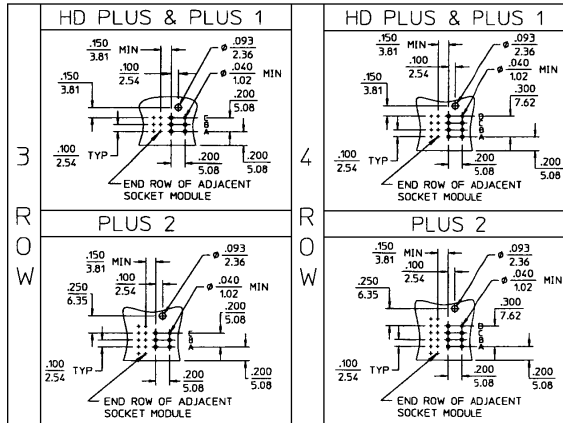

Recommended P.C. Board Hole Patterns

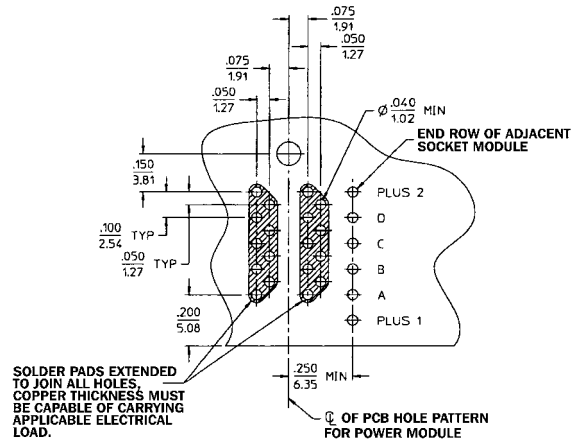

Ordering Information

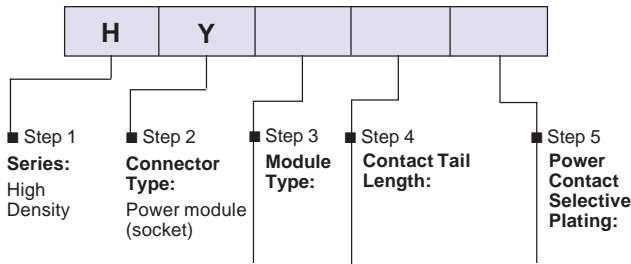

Code	Description	L	M
30	3 Row +0, +1 Power Module	.970 24.64	.450 11.43
32	3 Row +2, +3 Power Module	1.070 27.18	
40	4 Row +0, +1 Power Module		.570 14.48
42	4 Row +2, +3 Power Module	1.170 29.72	

Code	Quantity	G
01	2	.150 3.81
02	2	.125 3.18

Code	Mating Area	Solder Tail
BD	Gold flash over Palladium-Nickel	Tin-lead
GE	50 Microinches min. gold	

Ordering Information

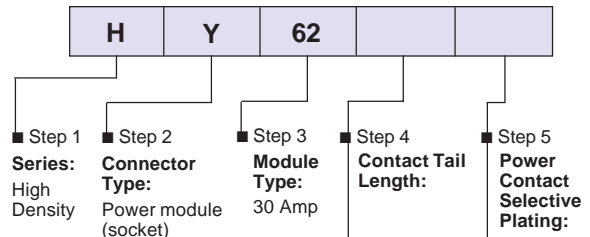

Code	Quantity	G
01	2	.150 3.81
02	2	.125 3.18

Code	Mating Area	Solder Tail
BD	Gold flash over Palladium-Nickel	Tin-lead
GE	50 Microinches min. gold	

Socket Module 3 and 4 Row 15 and 20 Positions

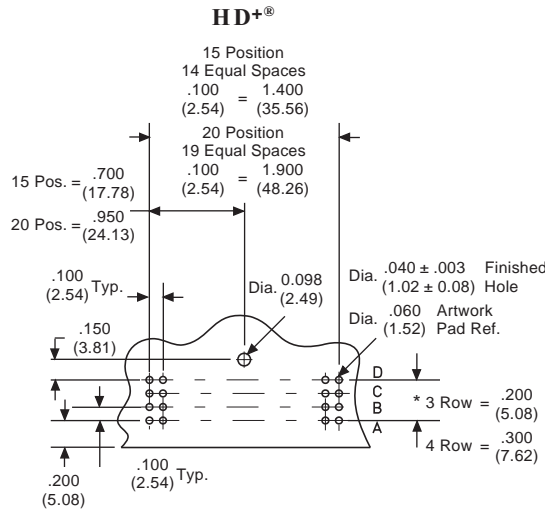

Accessory 3 and 4 Row Hole Patterns

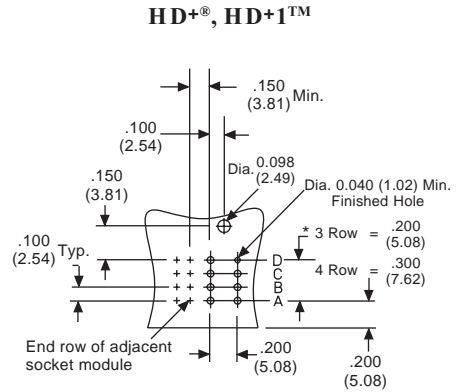

Power Module

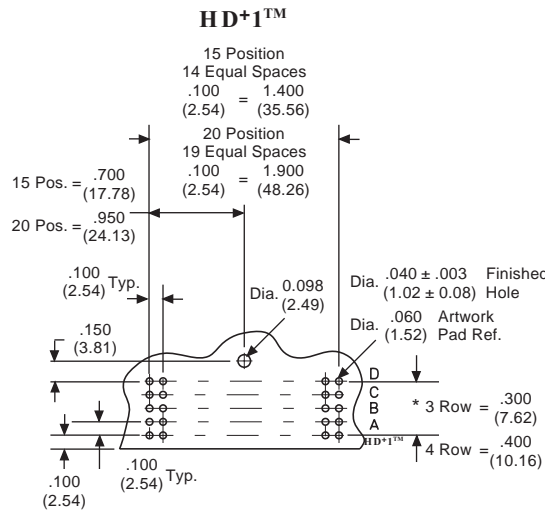

HD+2™

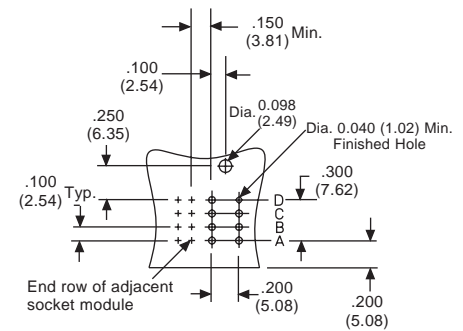

HD+2™

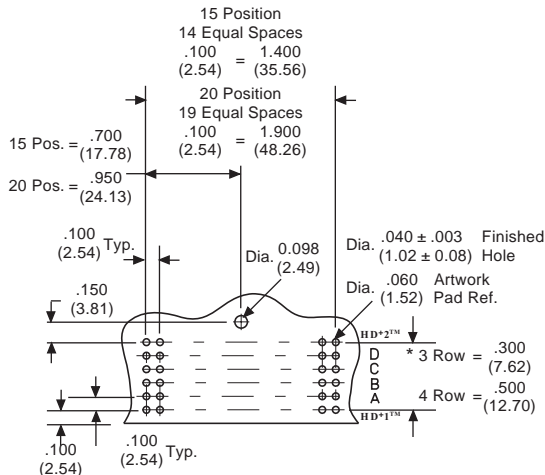

Guide Pin Receptacle/Polarizing Module

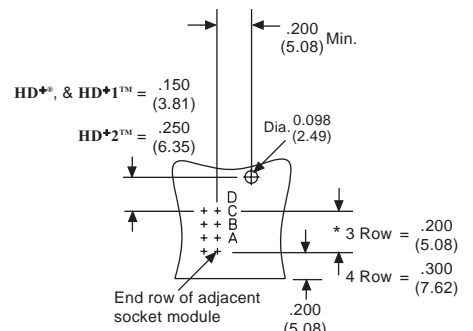

* Delete row D for 3 row hole patterns

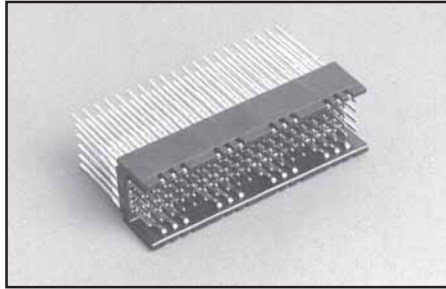

Backpanel Modules

Pin connector modules are end-stackable on .100 inch spacing and available in 3 and 4 row versions. Each as either 15 or 20 contact positions per row. The insulators are available with both ends open for continuous stacking, with one end wall to be positioned at the ends of a stack for longitudinal guidance; and, with one end polarization.

There are several types of HD+® pin contacts available. "Standard" pin and an "Extended" pin allow selected ground connections to make contact first and break last. When daughter-cards are engaged or disengaged with the backpanel pins on a "live" system, this "first make/last break" ground connection prevents transient currents from passing into the fixed voltage traces on the daughtercard. The I/O contact tail variations include a stub tail or a longer tail suitable for 3 levels of solderless wire wrapping. These long tails also provide rear

plug-up capability to standard socket connectors. Plus rows of contacts in the pin modules are located within the side walls of the insulator. They employ a preloaded cantilever spring design similar to those found in cardedge connectors. They provide pathways for power or low inductance ground connection (shielding).

Power Distribution Parameters

External Busing

External busing systems are mounted to the top or bottom surfaces of the backpanel and are typically used in high power applications. Aluminum, copper, or brass bus bars create the busing structure and also serve as backpanel stiffeners. Consult the factory for further details.

- Reduces complexity of multilayer boards
- Economical for high power applications
- Provides backpanel rigidity, eliminates warpage

Internal Distribution

Internal power distribution utilizes the inner layers and traces of the backpanel. It is typically used for low power applications.

- Economical for low power applications
- Minimizes consumption of backpanel real estate, 2-4 oz. copper
- Use of HD+1™ and HD+2™ contacts

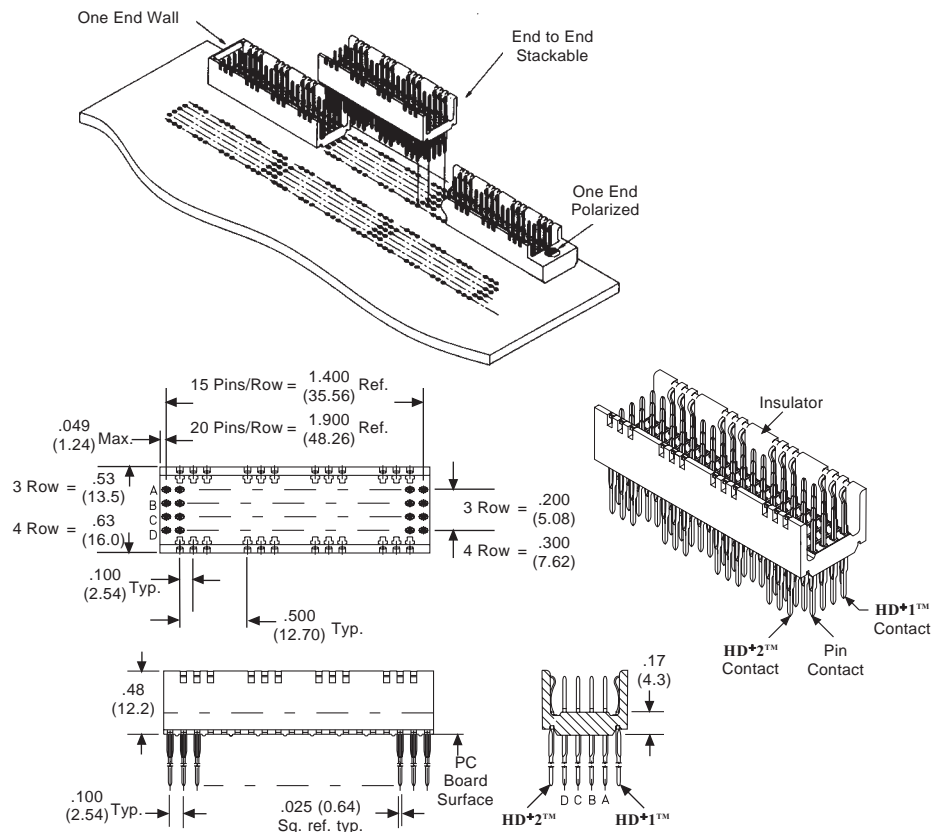

ORDERING INFORMATION

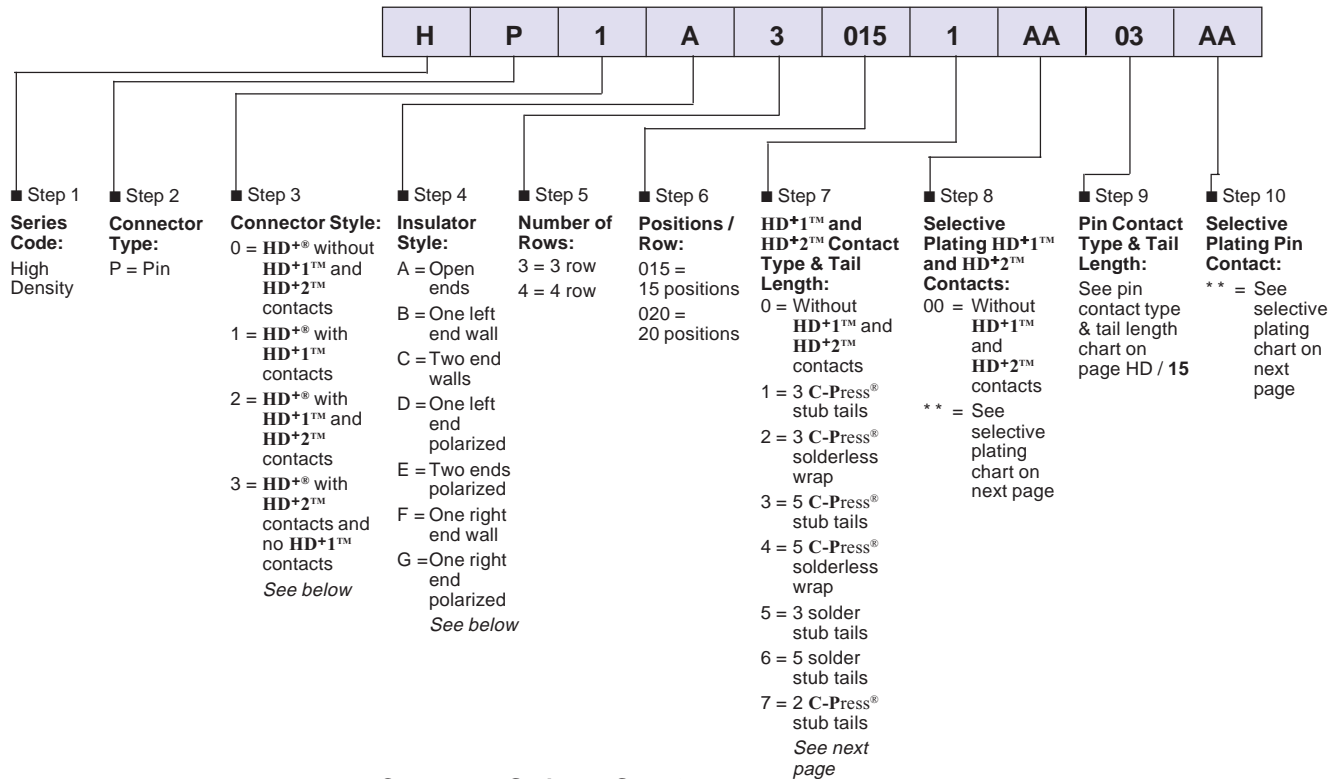

Connector Style — Step 3

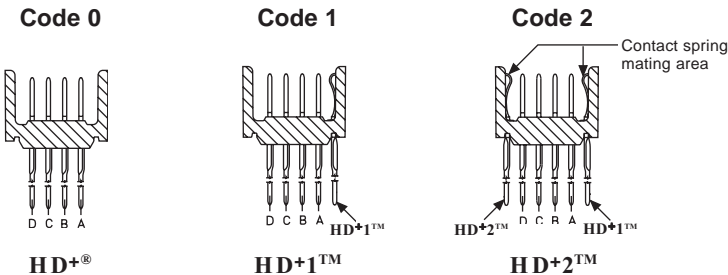

Insulator Style — Step 4

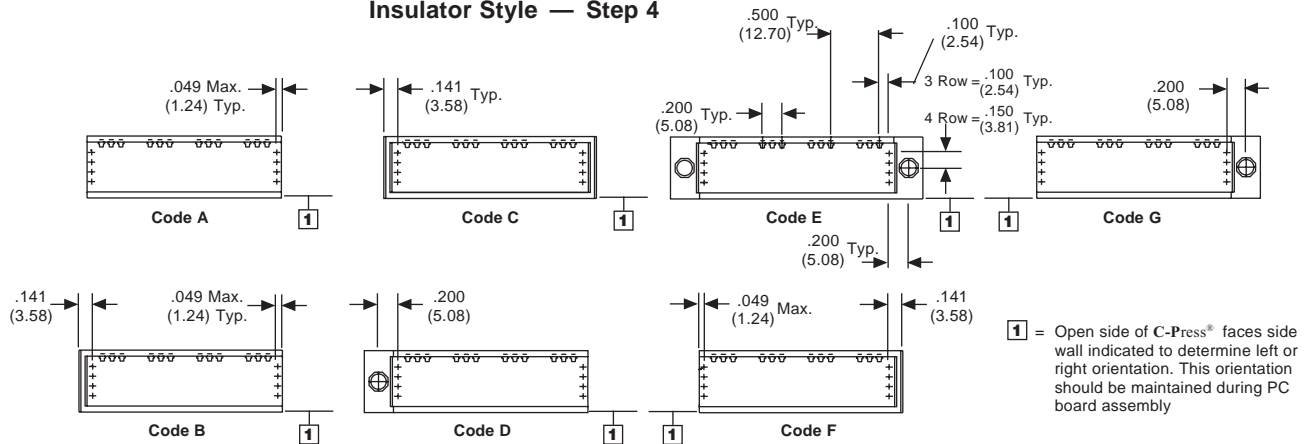

Number Of Rows — Step 5

Code 3

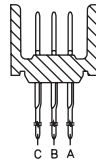

3 Row Module

Code 4

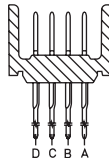

HD+1™ and HD+2™ Contact Clusters — Step 7

Code 1

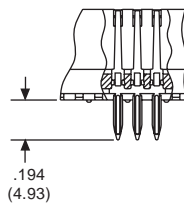

Code 2

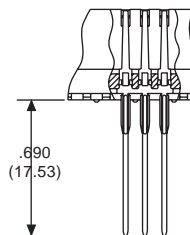

Code 3

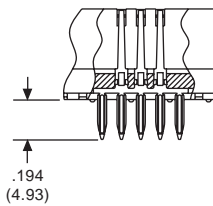

Code 4

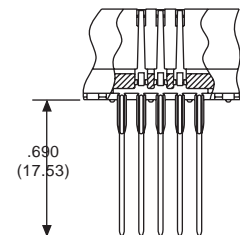

Code 5

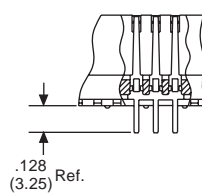

Code 6

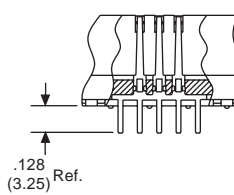

Code 7

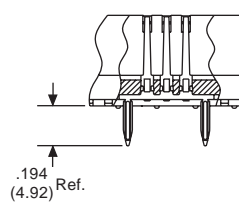

Selective Plating Chart — Step 8 and 10

Description	** Code	Mating Area	Solderless Wrap Plating Area
C-Press® ground contact and pin with stub tails	AA	.000030 (0.00076) min. gold	.000015 (0.00038) min. tin-lead
	BJ	Gold flash over .000040 (0.00101) min. PdNi	
	GA	.000050 (0.00127) min. gold	
C-Press® ground contact and pin with solderless wrap tails	AB	.000030 (0.00076) min. gold	.000100 (0.00254) min. tin-lead
	GB	.000050 (0.00127) min. gold	
	EA	.000030 (0.00076) min. gold	gold flash
C-Press® pins with rear plug-up tails	CA	.000030 (0.00076) min. gold	Mating area: .000030 (0.00076) min. gold
C-Press® ground contact and pin with stub tails	BG	Gold flash over .000025 (0.00064) min. PdNi	.000015 (0.00038) min. tin-lead
C-Press® pins with rear plug-up tails	DB	Gold flash over .000025 (0.00064) min. PdNi	Mating area: Gold flash over .000025 (0.00064) min. PdNi
Ground contact and pin with solder stub tails	AC	.000030 (0.00076) min. gold	.000100 (0.00254) min. tin-lead solder stub tails only
	BH	Gold flash over .000025 (0.00064) min. PdNi	
	GC	.000050 (0.00127) min. gold	

Note: Contact underplate .000050 min. nickel overall

Standard Backpanel Application — Step 9

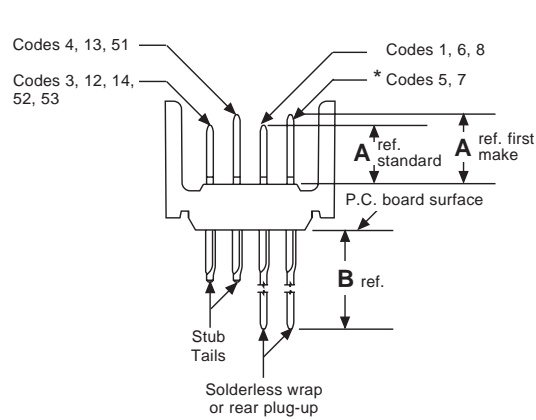

Midplane Application — Step 9

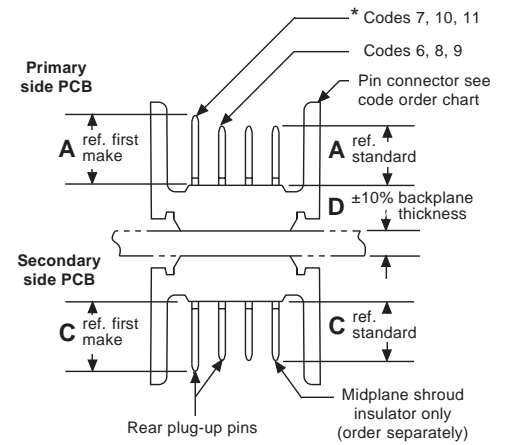

Pin Contact Type and Tail Length — Step 9

Type	Code	Description	Standard Backpanel		Midplane Application	
			A	B	C	D
Standard	03	C-Press® stub	.220 (5.59)	.194 (4.93)	—	—
	01	C-Press® solderless wrap or rear plug-up		.690 (17.53)	—	—
	08		.576 (14.63)	.220 (5.59)	.186 (4.72)	
	06		.493 (12.52)	.230 (5.84)	.093 (2.36)	
	09	.523 (13.28)	.125 (3.18)			
	12	C-Press® stub	.240 (6.10)	.194 (4.93)	—	—
	14	Solder stub tail	.220 (5.59)	.325 (8.25)	—	—
	52		.220 (5.59)	.128 (3.25)	—	—
53	.240 (6.10)		—	—		
First Make	04	C-Press® stub	.260 (6.60)	.194 (4.93)	—	—
	05	C-Press® solderless wrap or rear plug-up		.690 (17.53)	—	—
	07			.523 (13.28)	—	.093 (2.36)
	10			.553 (14.05)	.260 (6.60)	.125 (3.18)
	11	C-Press® stub		.616 (15.65)	—	.186 (4.72)
	13			.325 (8.26)	—	—
	51	Solder stub tail		.128 (3.25)	—	—

* Note: Consult factory for selective loading of first make pins

ORDERING INFORMATION

C-Press® Replacement Pin Contacts

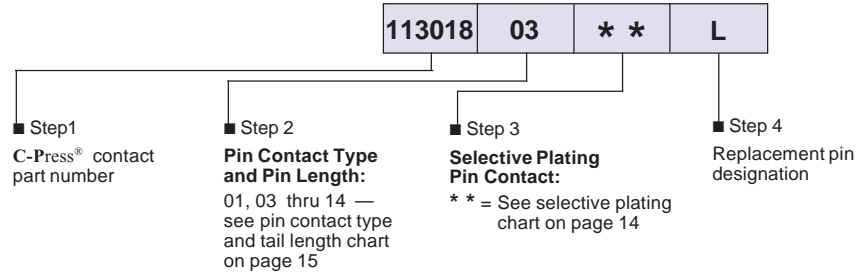

C-Press® Replacement Ground Contacts

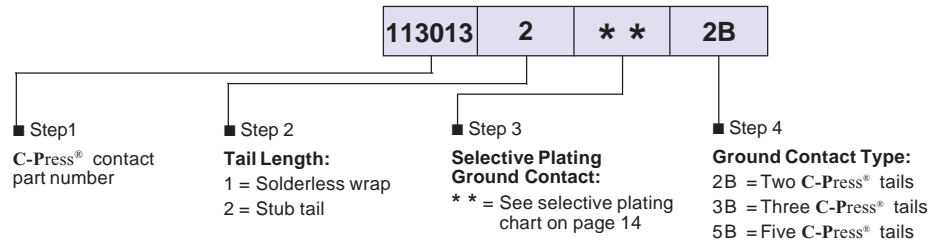

Solder Tail Replacement Pin Contacts

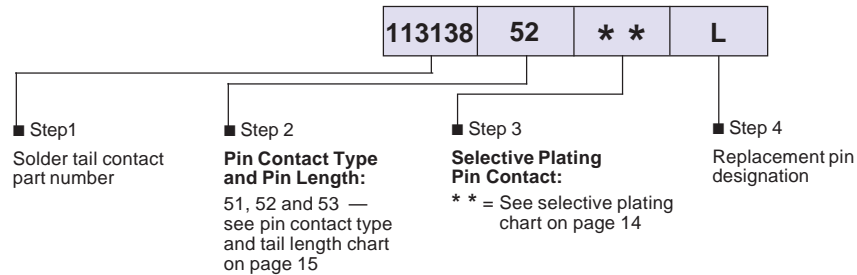

Solder Tail Replacement Ground Contacts

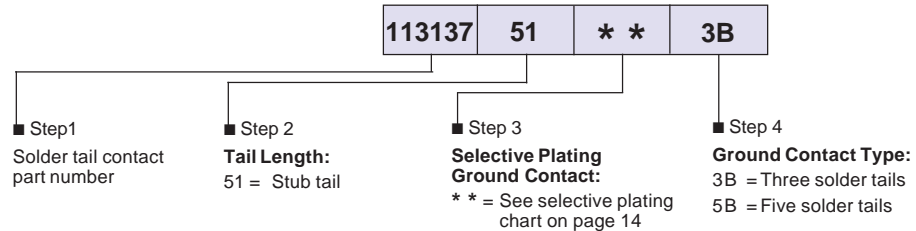

Midplane Shroud 4 Row Part Numbers — Letter Codes Refer To Step 4

	Code A	Code B or F	Code C	Code D or G	Code E
15 Positions	113028-12	113028-18	113028-20	113028-14	113028-16
20 Positions	113028-11	113028-17	113028-19	113028-13	113028-15

Dual Power Blade Module For Internal Power Distribution

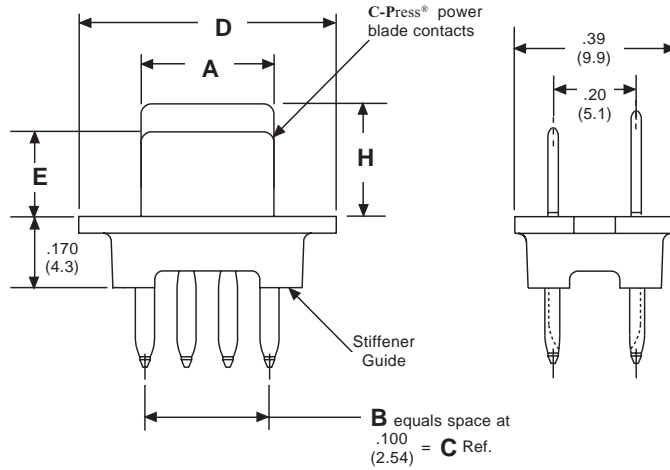

113084 2 BA

■ Step 1
C-Press® power blade
module part number

■ Step 2
Contact Code:

■ Step 3
Selective Plating:

Part Number	PC Board Hole Pattern	A	B	C	D	E	H
113084-1-**	J	.220 (5.59)	2	.200 (5.1)	.52 (13.2)	.202 (5.13)	.202 (5.13)
113084-2-**	P	.320 (8.13)	3	.300 (7.62)	.62 (15.7)	.202 (5.13)	.202 (5.13)
113084-3-**	J	.320 (8.13)	3	.300 (7.62)	.62 (15.7)	.262 (6.65)	.262 (6.65)
113084-4-**	J	.320 (8.13)	3	.300 (7.62)	.62 (15.7)	.202 (5.13)	.262 (6.65)

Code	Description	Contacts (2 per)
1	3 row	3 C-Press®
2	4 row	4 C-Press®
3	4 row	4 C-Press®
4	4 row	4 C-Press®

Code	Mating Area	C-Press® Area and Stub Tail
BA	Gold flash over .000028 (0.00071) Min. Palladium Nickel	.000020 (0.00051) Min. Tin-lead
GA	Min. Gold .000050 (0.00127)	

Power Blade Shroud

Protects exposed power blade contact while maintaining plugability of four row daughtercard socket power module.

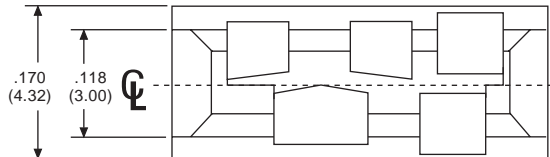

Part Number	Power Blade Type	Used With Blade Catalog Number
113173-4	BUSS Bar — 4 row	113071-4,-5, or -89
113173-3	P.C.B. Mount — 4 row	113084-2-**

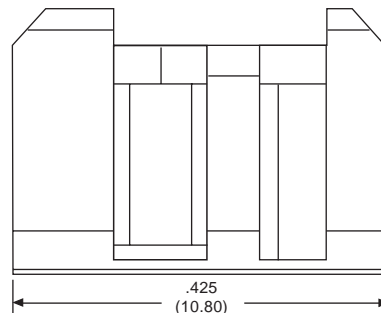

Part Number 113173-1 Shown

Power Blade Contacts — Used With Aluminum Bus Bar

Part Number	Type	PC Board Hole Pattern	Bus Bar Hole Pattern
113071-9	III	K	J
113071-8	I	H	J
113071-7	II	N	P
113071-5	VI	H	H
113071-4	IV	J	J
113071-1	VII	P	P

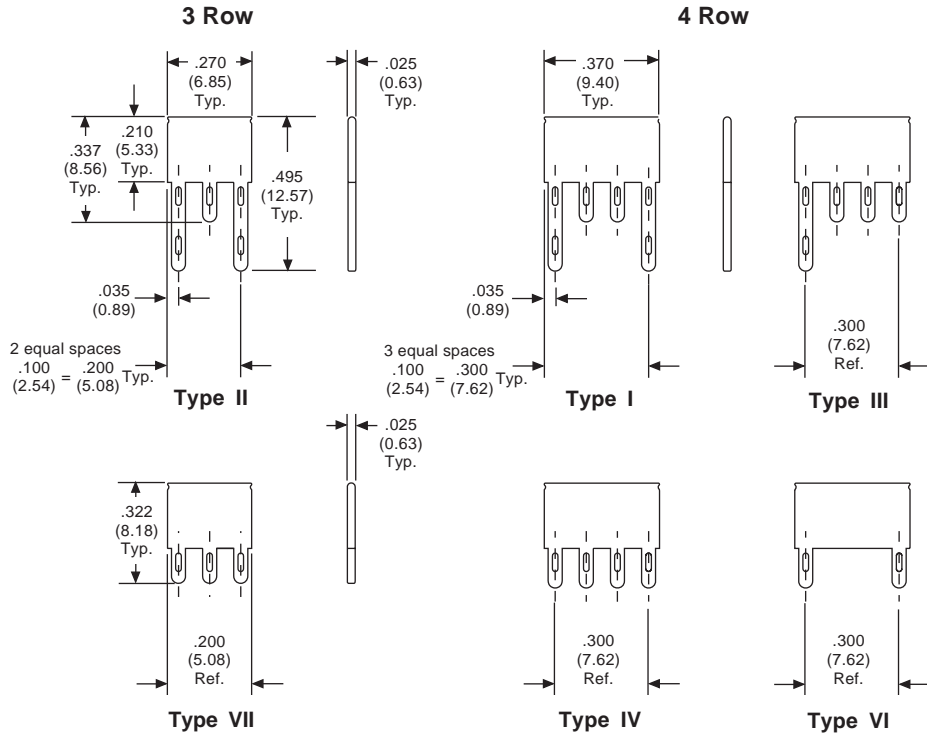

Material: Phosphor Bronze Alloy C52100 per QQ-B-750, composition A.

Finish: .000030 (0.00076) Min. gold over
.000075 (0.00191) Min. nickel

Recommended Hole Patterns For Power Blades

Description	V
End polarized	.450 (11.43)
End wall	.250 (6.35)
Open ends	.150 (3.81)

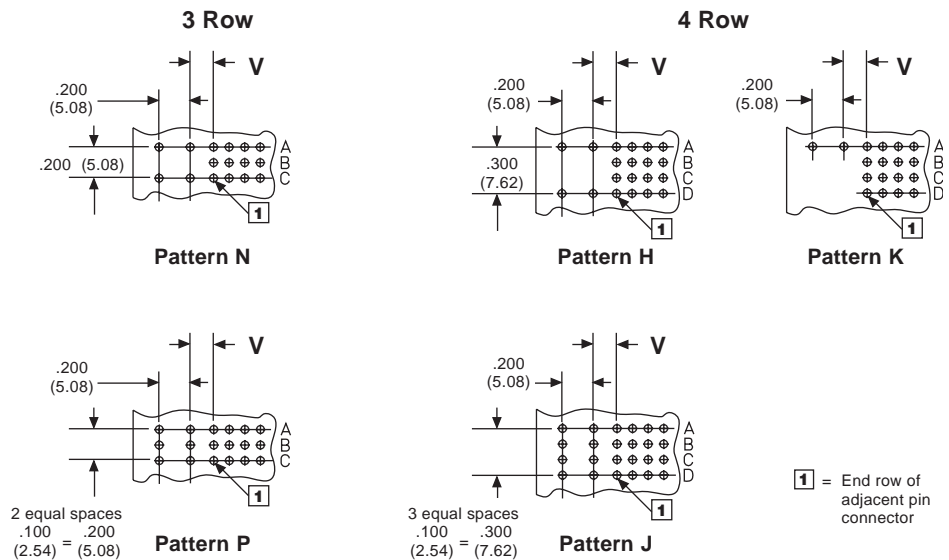

Note: Power blade contact holes are shown at the minimum spacing required for modules to be end stackable

Guide Pins — Standard

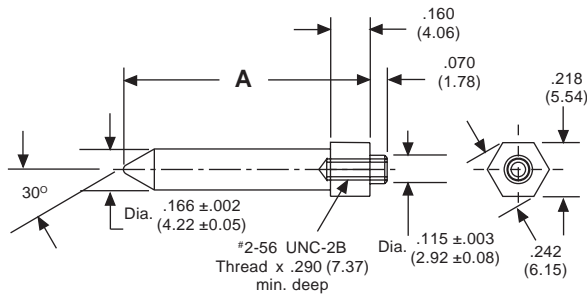

Part Number **113152-1** Shown

Part Number	Dimension A
113152-2	.810 (20.57)
113152-1	1.000 (25.40)

Material: Stainless steel. Order separately under part number **113152-1**. Guide pin option requires corresponding guide pin receptacle on daughterboard connector assembly — see page HD / 11 for part number identification. A guide pin is also required on applications that specify polarization.

Guide Pins — Midplane

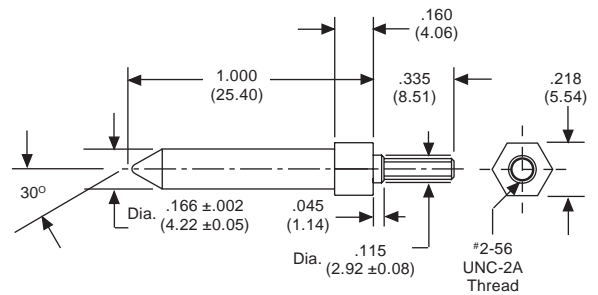

Part Number **113151-1**

Material: Stainless steel. Order separately under part number **113151-1**.

Screw Part Number	L	M
114025-1	.375 (9.53)	.191 to .315 (4.85) to (8.00)
114025	.250 (6.35)	.084 to .190 (2.13) to (4.83)

Standard Guide Pins — Assembly

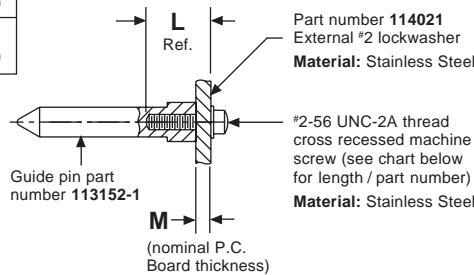

Midplane Guide Pins — Assembly

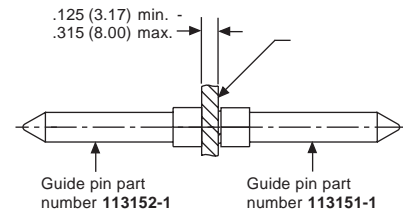

Part Number	Dim. A	Dim. B
113165-2	.248 (6.23)	.19 (4.8)
113165-1	.188 (4.78)	.11 (2.8)

Press-Fit Guide Pins

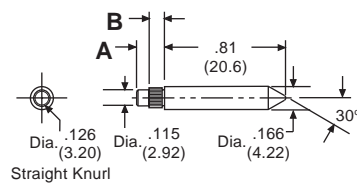

Part number **113165-1** shown. Diameter .118 ± 0.002 non-plated thru P.C.B. hole (required).

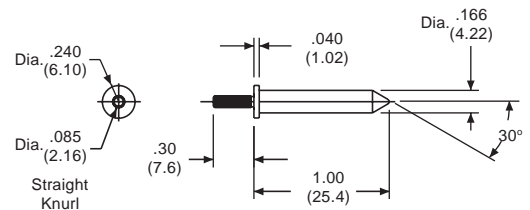

Part number **113163-1** shown. For use in midplane applications with part number **113165**. Recommended for use on backpanels .125 to .315 nominal thick.

Note: See page HD/25 for recommended mounting hole patterns

Right Angle HD+® Pin Connector

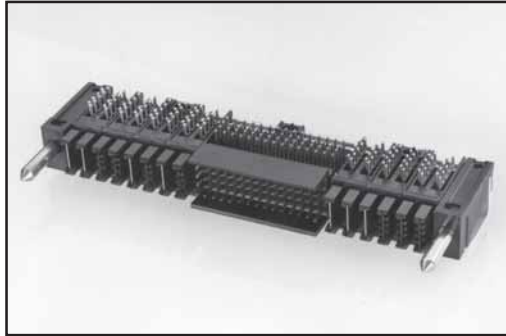

Winchester Electronics now offers a right angle male HD+® connector for connecting backpanel to backpanel, motherboard to motherboard and extension boards.

This HD+® right angle male connector mates without HD+® right angle female connectors and has power modules that carry up to 30 Amps per contact or 60 Amps per module.

Ask your Customer Service Coordinator for drawing #28500

Typical Connector Assembly Profile

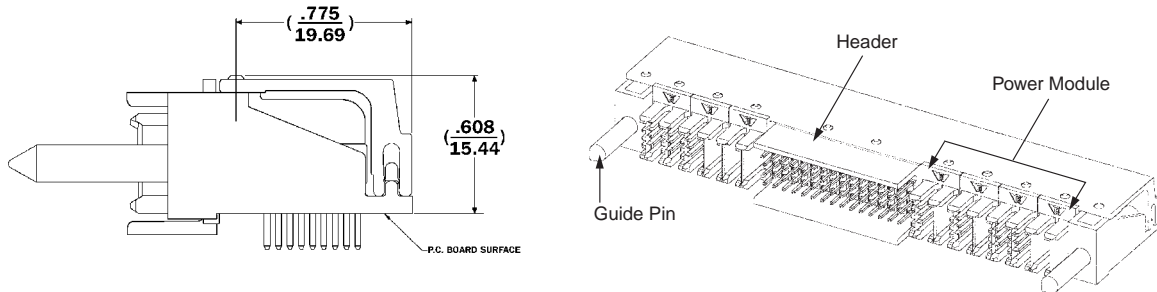

ORDERING INFORMATION

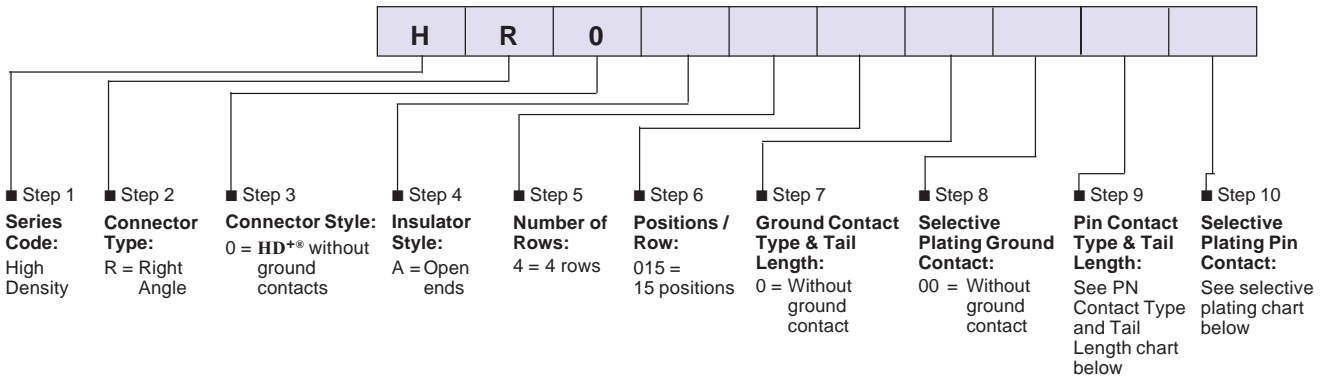

Pin Contact Type & Tail Length Chart

Type	Code	Description	A	B
Standard Make	56	Solder Stub Tail	.220	.150 3.81
	54		5.59	.125 3.18
First Make	57		.260	.150 3.81
	55		6.60	.125 3.18

Selective Plating Chart

Code	Description	Mating Area	Solder Tail Area
AK	Pin Contacts	.000030 0.00076 Min Gold	.000100 0.00254 Min Tin-Lead

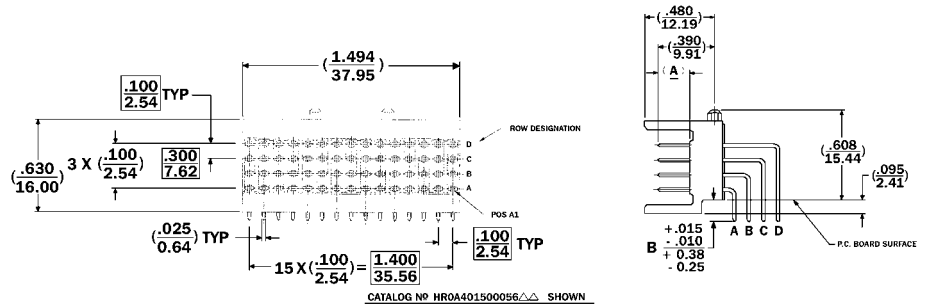

Recommended P.C. Board Hole Pattern

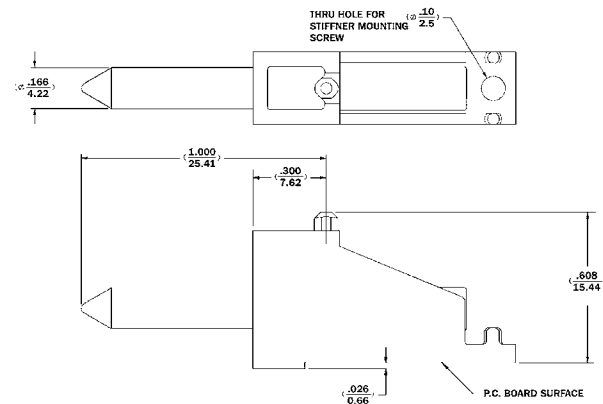
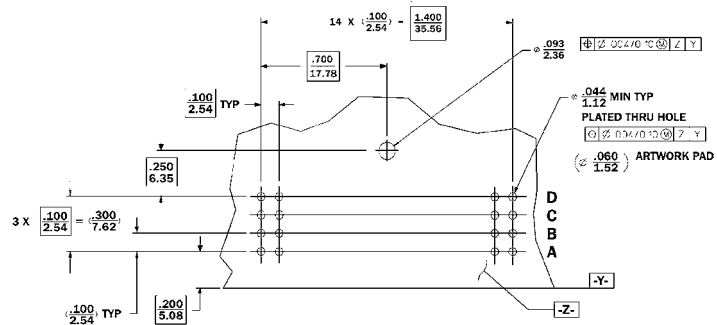

PART No HRG42001 SHOWN

Recommended P.C. Board Hole Pattern

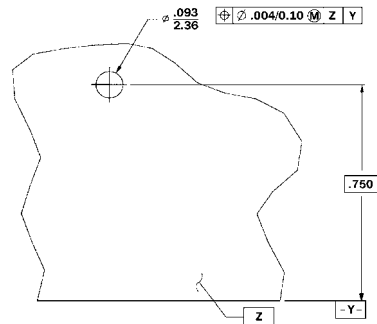

POWER MODULE



Winchester Electronics understands the needs of our customers for more and more power in their systems. To satisfy these needs, we now offer a 30 Amp power contact in the HD+® connector system that takes no additional real estate. Each power module consists of two contacts that can carry up to 30 Amps each to give you **60 Amps per module!**

Part Number HRP420302△△ Shown

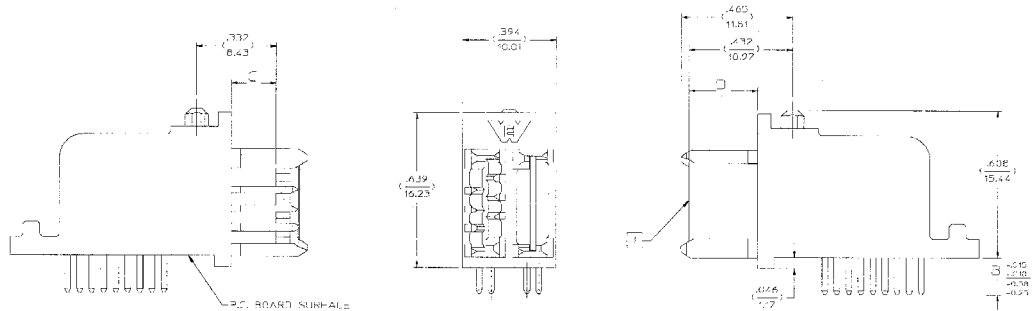

Recommended P.C. Board Hole Pattern (component side shown)

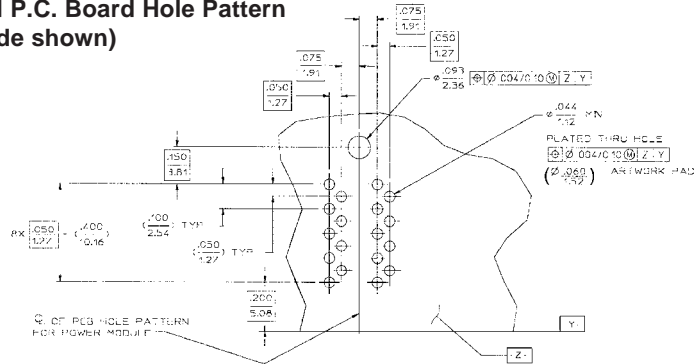

ORDERING INFORMATION



Step 1
Series Code:
High Density

Step 2
Connector Type:
RP = Right Angle, Power Module

Step 3
Module Type:
42 = 4 Row, HD+2™

Step 4
Blade Height:

Code	Description	C	D
01	VLOW/VLOW		(.187/4.75)
02	VLOW/LOW	(.187/4.75)	(.227/5.76)
03	VLOW/HIGH		(.287/7.29)
04	LOW/VLOW		(.187/4.75)
05	LOW/LOW	(.227/5.76)	(.227/5.76)
06	LOW/HIGH		(.287/7.29)
07	HIGH/VLOW		(.187/4.75)
08	HIGH/LOW	(.287/7.29)	(.227/5.76)
09	HIGH/HIGH		(.287/7.29)

Step 5
Tail Length:

Code	B
01	.125
02	.150

Step 6
Selective Plating Pin Contact:
See selective plating chart below

Selective Plating Chart

Code	Description	Mating Area	Solder Tail Area
GJ	Blade Contacts	.000050 0.00127 Min Gold	.000100 0.00254 Min Tin-Lead

MOUNTING SCREWS

Typical Final Assembly Connector Shown Assembled To P.C. Board

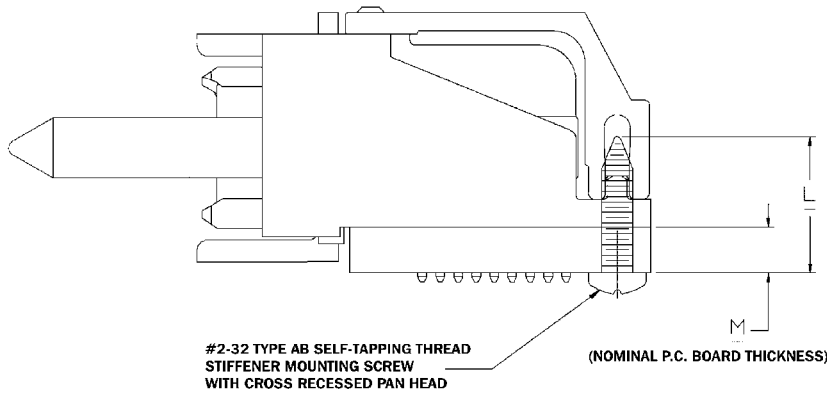

113069-1	.375 9.53	.094 TO .166 2.38 4.22
113069	.312 7.92	.031 TO .093 0.79 2.36
PART NO	L	M

Mounting screw part number 113069-1 shown in final connector assembly

MOUNTING SPACER

Consult Factory For Use On Stiffeners Containing Unsupported Spans

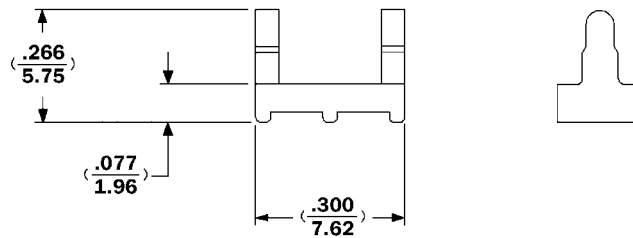
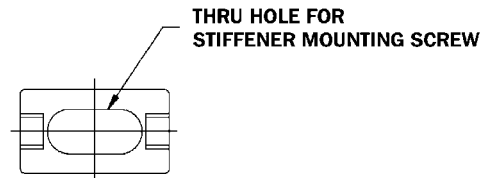

Part Number 113000 Shown

Pin Module 3 and 4 Row 15 and 20 Positions

HD+® — Code 0

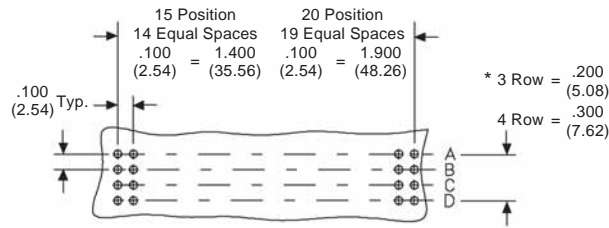

HD+1™ & HD+2™ Contact — Code 1, 2 or 5

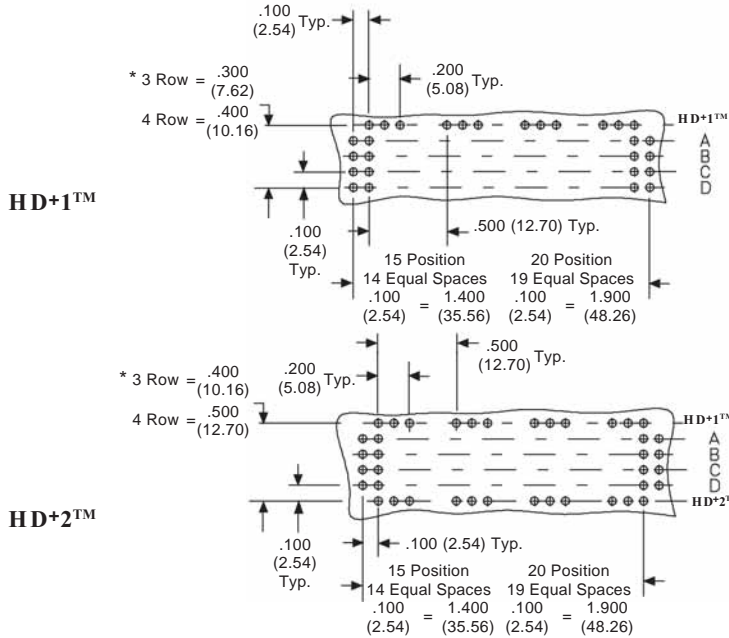

HD+1™ & HD+2™ Contact — Code 3, 4 or 6

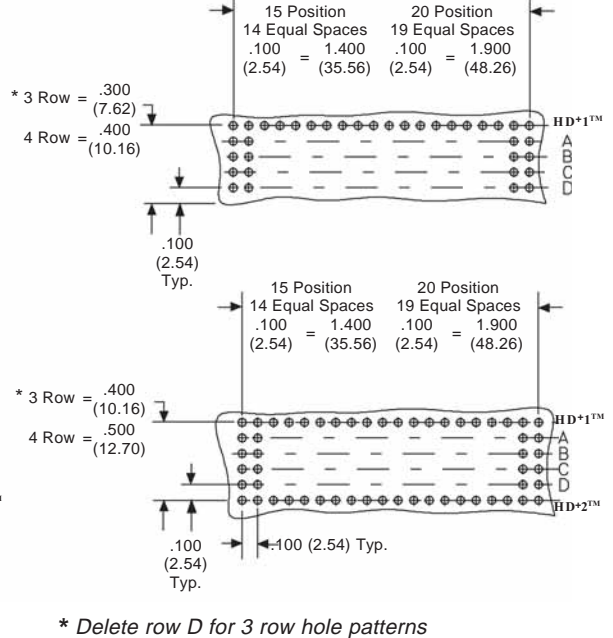

Right Angle HD+®

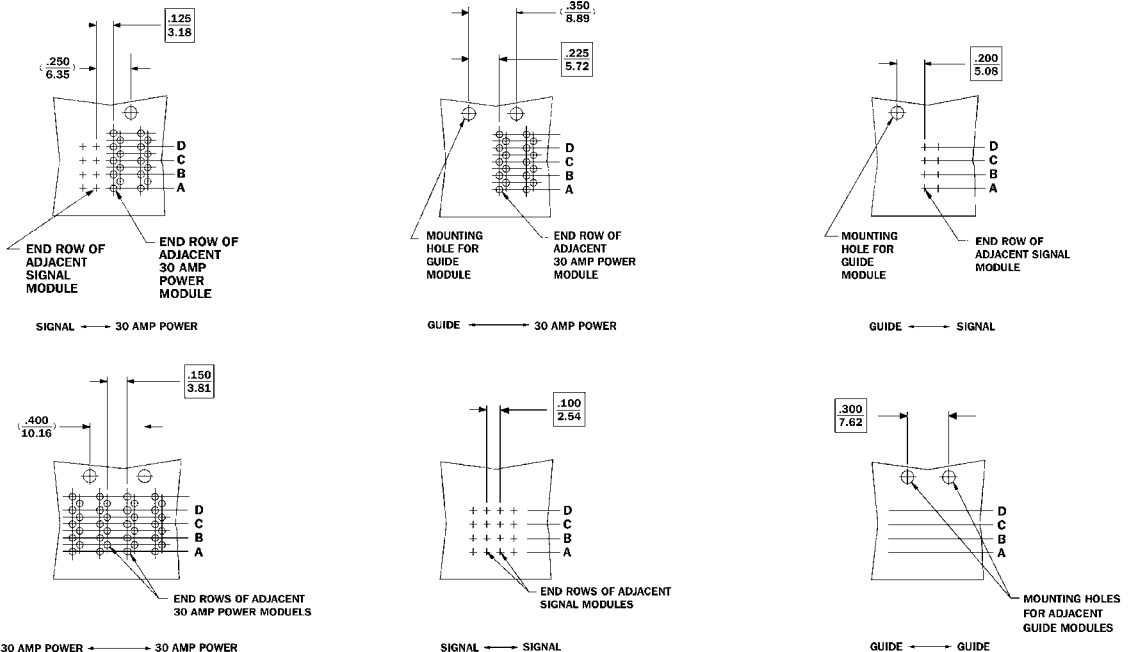

Recommended Mounting Hole Patterns

Guide pin holes are shown at the minimum spacing required for guide pin modules to be end stackable.

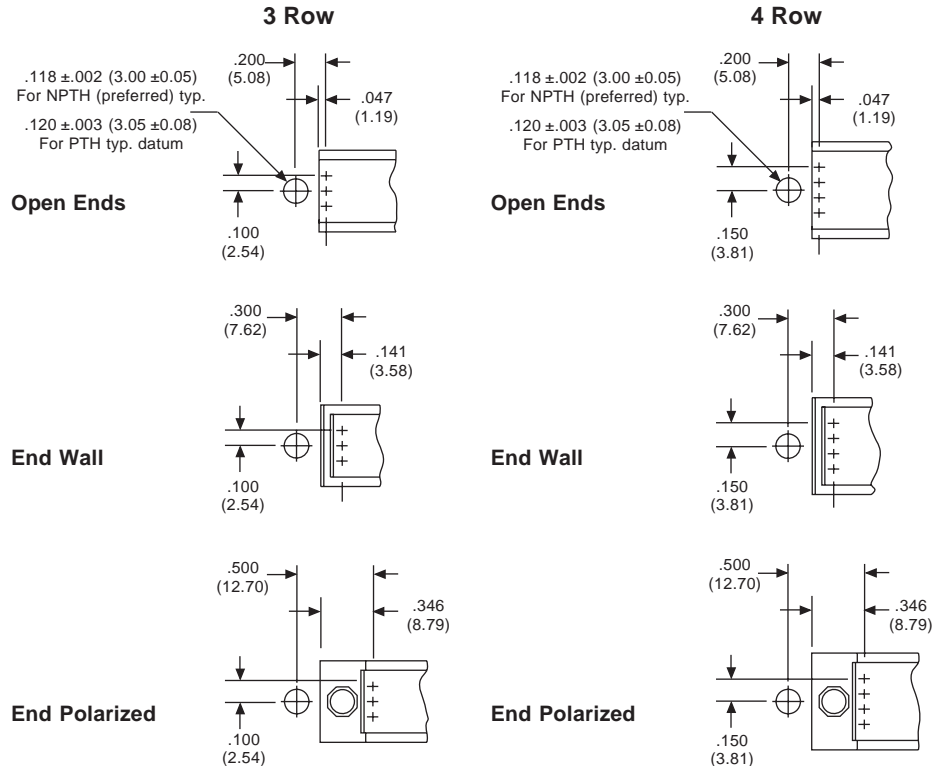

Note: Refer to Litton Electronic System Packaging HD+® Backpanel Design Guide for accessory configurations not shown.

Polarization Bushing

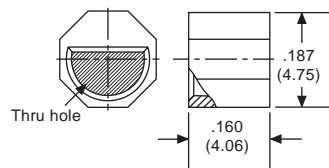

Part Number 113037-2

Material: Sintered stainless steel. Order separately under part number 113037-2. Bushing press fits into pin connector with installation tool part number 107-43240.

Removal Tool: Part number 107-43241

Consult factory to order bushings preassembled into pin connector.

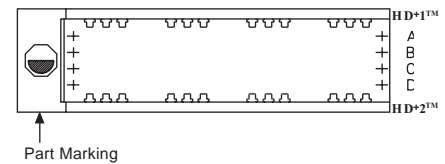

Code A Shown

Note: Orientation with respect to row designation for mating connectors.

Polarization Style			
Code	Clocking Position	Code	Clocking Position
A		E	
B		F	
C		G	
D		H	

SPECIFICATIONS**MATERIALS AND FINISHES**

The following materials and finishes apply to all High Density Plus series daughtercard and backpanel connector modules.

Insulators: Thermoplastic polyester, glass filled, color black, UL rated 94 V-O.

BACKPANEL CONTACTS**Signal Contacts:**

Material: Copper alloy

Finish: See Selective Plating Chart on page HD / 14

HD+1™ & HD+2™ Contacts:

Material: Copper alloy

Finish: See Selective Plating Chart on page HD / 14

Dual Power Blade Contacts:

Material: Copper alloy

Finish: See Selective Plating Chart on page HD / 17

DAUGHTERCARD CONTACTS**Signal Contacts:**

Materials: Copper alloy

Finish: See Selective Plating Chart on page HD / 6

HD+1™ & HD+2™ Contacts:

Material: Copper alloy

Finish: See Selective Plating Chart on page HD / 6

Power Module Contacts:

Material: Copper alloy

Finish: See Selective Plating Code Chart on page HD / 10

Daughtercard Stiffener: Extruded aluminum alloy 6061-T6 per QQ-200/8.
Clear anodize finish per MIL-A-8625.

Stiffener Mounting Screws: CRES Type 302, passivated

Polarizing Bushings: Sintered metal CRES Type 316

Polarizing & Guide Pins: CRES Type 303, passivated

Guide Pin Screws: CRES Type 303, passivated

Guide Pins: CRES Type 203, passivated

HD+® ACCESSORY TOOLING — Repair Tools

DESCRIPTION	CATALOG NUMBER
Polarization Key (Socket Connector)	
Polarization Key Removal Tool	107-43248
Polarization Key Insertion Tool	107-43247
Polarization Bushing (Pin Header)	
Polarization Bushing Removal Tool	107-43241
Polarization Busing Insertion Tool	107-43240
Dual Power Blade Module Insertion Tool	
3 Row	107-43313
4 Row	107-43312

SPECIFICATIONS

OPERATING CHARACTERISTICS

Signal Contact Resistance:	20 milliohms maximum initial
C-Press® Contact to Plated Through Hole Resistance:	2 milliohms (max)
HD+1™ Contact Resistance:	4 milliohms maximum
HD+2™ Contact Resistance:	7 milliohms maximum
Power Blade Contact Resistance:	1.5 milliohms maximum
Signal Contact Normal Force:	75 g minimum
Power Contact Normal Force:	100 g minimum
HD+1™ & HD+2™ Contact Normal Force:	100 g minimum
Individual Signal Contact Engagement Force:	2.5 oz max average
Individual Signal Contact Separation Force:	0.5 oz minimum
Contact Life (Durability):	200 cycles, with 30 microinches plating on mating contacts, and 500 cycles, with 50 microinches plating on mating contacts
C-Press® Signal Contact to Backpanel Retention:	10 lb minimum
C-Press® Signal Contact torque:	3.0 in.-oz minimum
Insulation Resistance:	5000 megohms minimum
Voltage Rating @ Sea Level (@ 60 Hz):	1000 Vrms
Signal Contact Current Rating:	1 A @ 70° C, 3 A Maximum
HD+1™ & HD+2™ Contact Current Rating:	4 A @ 70° C, 8 A Maximum
Power Contact Current Rating:	20 A @ 70° C, 25 A Maximum
Temperature Range:	-55° C to +105° C

HOLE SIZE REQUIREMENTS

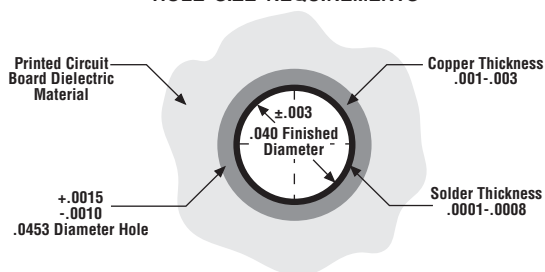

Standard Diameter P.T.H.

- Hole drilled to $.0453 \pm .0015$, $-.001$ diameter.
- Plating thickness must be $.001$ to $.003$ copper and $.0001$ to $.0008$ solder.
- Final hole dimension must be gauged to $.040 \pm .003$ diameter.
- See Winchester drawing number 27331

HD+® PIN HEADER TOOLING — Repair Tools

DESCRIPTION	CATALOG NUMBER	DESCRIPTION	CATALOG NUMBER
Pin Contact Repair		Shroud & Insulator Repair	
Single Contact Pullout Tool	107-43238	Removal Tool 4 x 15	107-43234
Single Contact KO Tool Handle	107-42500	Removal Tool 3 x 15	107-43235
Single Contact Seating Tool Tip	107-43230	Removal Tool 4 x 20	107-43236
Single Contact KO Tool Tip	107-42031	Removal Tool 3 x 20	107-43237
Ground Contact Repair		Seating Tool 4 x 15	
Removal Tool	107-43239	Seating Tool 3 x 15	107-43246
Insertion Arbor Press Tool	107-43232	Seating Tool 4 x 20	107-43243
		Seating Tool 3 x 20	107-43245

Signal Integrity of the High Density Plus Family

It has been determined that the **HIGH DENSITY PLUS®** connector family, together with a proper choice of grounding pattern, is suitable for inclusion in system designs where risetime is equal to or less than 700 ps. Crosstalk characteristics of the **HIGH DENSITY PLUS®** connectors, especially **HD+2™**, are predictable and suitable for hi-performance system design.

Signal Reflection — HIGH DENSITY PLUS® Family Reduces Simultaneous Switching Noise

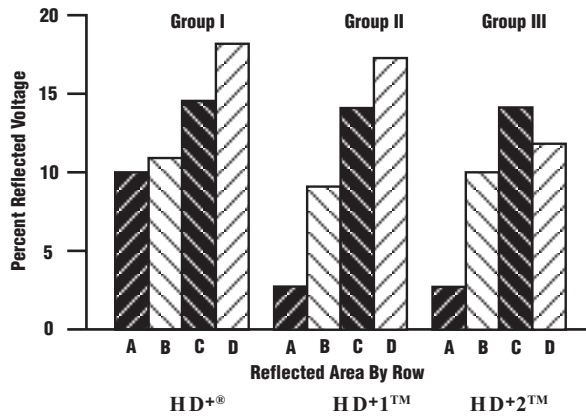

HIGH DENSITY PLUS® offers the advantage of up to two additional rows of contacts that can be used for low inductance grounding or power distribution.

A grounding scheme utilizing only 4% of the total pin contacts was selected to create a worst case condition and demonstrate how the “Plus” rows of contacts can improve signal integrity in that environment.

- Group I** — shows rows **A, B, C, D** experiencing signal reflections from 10% to 18%.
- Group II** — with **HD+1™** signal reflections are reduced and duration decreased.
- Group III** — combines **HD+1™** and **HD+2™** row contacts to provide exceptional shielding.

HIGH DENSITY PLUS® Sequence Of Mating

Contact	Electrical Overtravel*		Effective Wipe***
Guide Pin **	.510 (12.95)	.420 (10.67)	N / A
Insulators **	.310 (7.87)	.220 (5.59)	N / A
Pol Key **	.256 (6.50)	.166 (4.22)	N / A
Advanced Ground Contact	.223 (5.66)	.133 (3.38)	.190 (4.83)
Advanced Power Contact	.212 (5.38)	.122 (3.10)	.179 (4.54)
Standard Ground Contact	.198 (5.03)	.108 (2.74)	.165 (4.19)
Advanced Socket & Pin (.260") Signal Contacts	.155 (3.94)	.065 (1.65)	.123 (3.12)
Standard Power Contact	.152 (3.86)	.062 (1.57)	.120 (3.05)
Mid (.240") Signal Pin and Advanced Signal Socket Contacts	.135 (3.43)	.045 (1.143)	.102 (2.59)
Advanced (.260") Signal Pin and Standard Signal Socket Contacts	.130 (3.30)	.040 (1.02)	.100 (2.54)
Standard (.220") Signal Pin and Advanced Signal Socket Contacts	.115 (2.92)	.025 (.64)	.085 (2.16)
Mid (.240") Signal Pin and Standard Signal Socket Contacts	.110 (2.79)	.020 (.51)	.080 (2.03)
Standard (.220") Signal Pin and Standard Signal Socket Contacts	.090 (2.29)	0 (0)	.060 (1.52)

* **Electrical Overtravel** is the total distance of socket connector travel after initial contact has been made.

** Engagement is non-electrical.

*** **Effective Wipe** is defined as the total distance of socket connector travel after full contact engagement has been made.

 To standard signal pin and standard signal socket contacts

Crosstalk

In addition to signal reflections, another source of noise must be considered — crosstalk. Crosstalk is caused by the electromagnetic coupling of a “quiet” signal contact to a nearby “active” signal contact. There are two types of crosstalk to be concerned with; forward crosstalk and backward crosstalk. Crosstalk can be reduced by increasing the number of ground contacts because the electromagnetic fields created by the signal and ground contacts will cancel each other’s effects.

HD+® Crosstalk Measurements

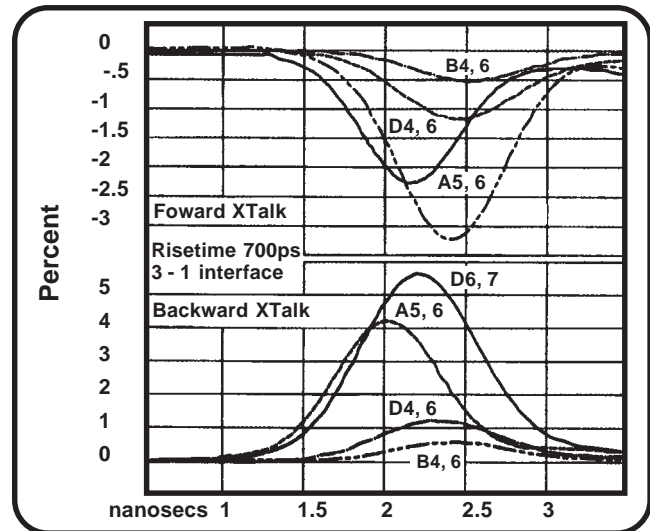

Worst case peak backward crosstalk of 5.6% was observed between adjacent pins 6 and 7 in the D row. Forward crosstalk was also largest for this pair of pins. Peak backward and forward crosstalk between adjacent A row pins was 4.2% and 2.2% respectively. The presence of the **HD+®** rows clearly reduces both the forward and backward crosstalk, even for the D row adjacent pins.

Crosstalk is most favorably affected by the presence of the **HD+1™** and **HD+2™** rows. The effects of the rows are clearly most important to the D row in the connector where the +2 row assists risetime response, reduces risetime loss and improves crosstalk performance by nearly 18%. For the most demanding of applications, the **HD+2™** connector provides significant improvements in system performance.

Compliant Contact

C-Press[®] "True" Compliant Press-Fit Connectors

Winchester Electronics offers the leading edge in compliant press-fit pins and connectors. In both design and performance, the C-Press[®] contact is the premium compliant pin.

Horizontal Cross Sections

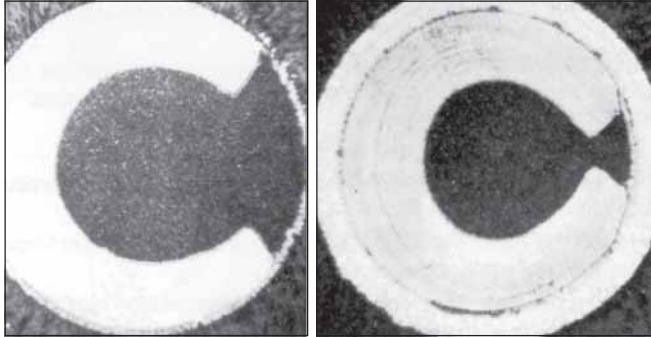

Macro-photo cut-away view of actual, unretouched, compliant contact "C" section. At maximum and minimum diameter, plated through-hole contact pressure is distributed evenly along the inside circumference of the plated through-hole. The "C" section ensures a gas tight connection without damaging the hole or warping the board.

The advantage of the C-Press[®] contact lies in its unique "C" shaped compliant section. Unlike two and four point press-fit systems, the crescent-shaped, tapered beam conforms naturally within the board to the shape of the plated through-hole. It expands or contracts to make contact around the circumference of the plated through-hole from .037" to .043" in diameter, exerting an equal normal force onto the entire surface of the hole, while forming a gas tight and extremely reliable electrical connection.

True Compliant Fit

Because the compliant section of the C-Press[®] contact neither warps a board nor distorts the hole, it is an excellent choice for use in multilayered and Multiwire[®] boards. A major concern with "press-fit" contacts is the amount of axial and radial deformation imparted to the plated through-hole as a result of contact insertion. Because our C-Press[®] contact offers a "True Compliant Fit," the concern for deformation damage to the plated through-holes and inner layers of a printed circuit board is eliminated.

Electronic designers no longer have to subject their expensive printed circuit boards to soldering or forcing a square peg into a round hole. Worries about delamination from soldering or damage by inserting square pegs disappear, and board warpage is significantly reduced.

Multiwire[®] is a Registered Trademark of Kollmorgen Corp.

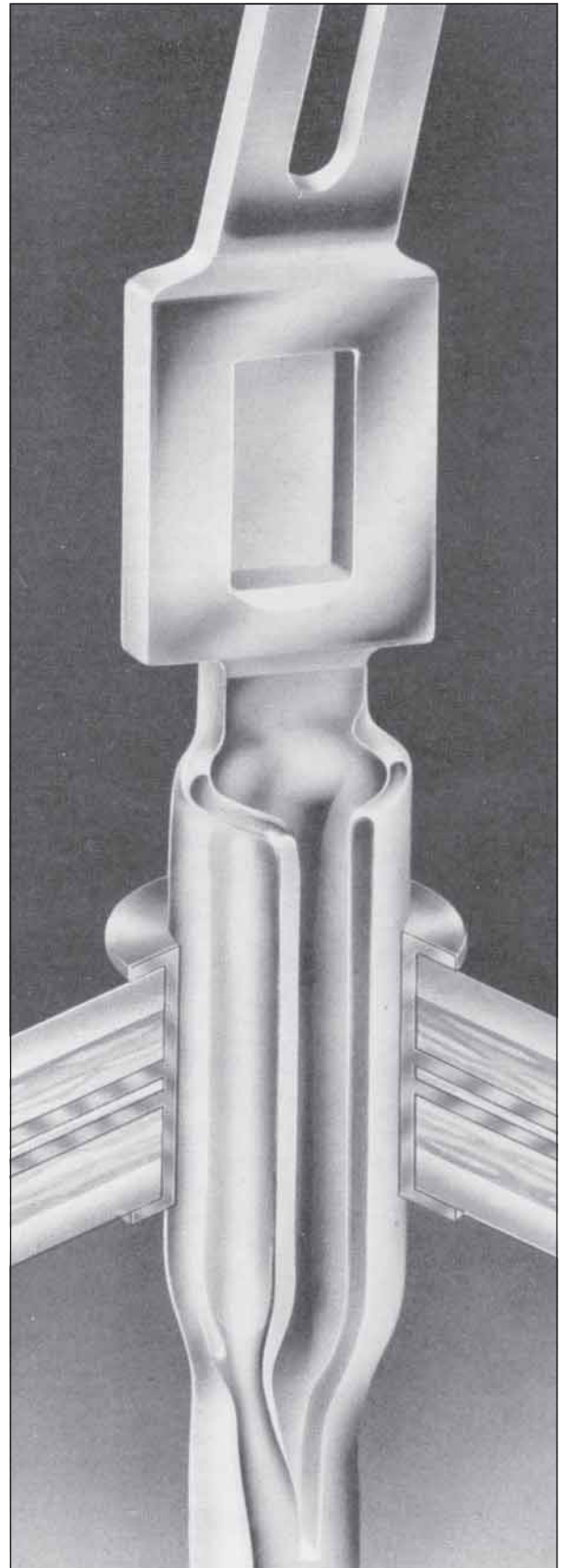

Winchester Electronics

62 Barnes Industrial Road North, Wallingford, Connecticut 06492 Phone:(203)741-5400 Fax:(203)741-5500 www.winchesterelectronics.com

In and Out of the Board ... Without Solder

Now, with the C-Press[®] contact, you can insert a round pin into a round hole. This innovative engineering achievement (Patent #4017143) ensures a spring action pin to absorb potentially destructive energy while providing excellent electrical characteristics. C-Press[®] contacts meet or exceed the performance specifications called for in MIL-STE-2166 and ANSI/IPC-D-422.

C-Press[®] contacts have been approved and are being used in high volume by major manufacturers of computer, medical and telecommunications equipment. Because C-Press[®] contacts are approved and used in 40-year life equipment, they clearly offer both dependability and performance.

The C-Press[®] system provides you with additional benefits such as rear plug-up, and the freedom to mount components on both sides of the board without costly masking or hand soldering operations.

Further benefits that save you time and money are the ability to remove and replace contacts through the insulator, as well as remove and replace an insulator without disturbing the contacts.

C-Press[®] contacts exhibit low insertion forces (40 lbs. max. per pin) and high retention forces (10 lbs. min. per pin), even after multiple replacements.

If damaged traces or the need to incorporate revisions in the existing connection system makes it necessary to alter interconnects at the circuit board level, the Winchester Electronics "Isolation Contact" is the answer. This contact can be installed into the existing PTH at the required position and effectively "Insulates" the contact from the circuitry at that location. Desired circuit alteration can then be completed by means of wire wrapping from point-to-point.

Tooling and Engineering Support

Winchester Electronics will work with and support your Backpanel Supplier of your choice. Many are familiar with our products and tooling. Connector and pin insertion equipment is available to set up an in-house, turn key operation. From a simple arbor press to a micro processor controlled hydraulic press with programmable X and Y axis, Winchester Electronics has the assembly equipment to fit your needs.

As new generations of semiconductor logic impose higher demands on production technology, the C-Press[®] true compliant pin can help promote a smooth transition into the future. C-Press[®] pre-assembled connectors will provide access to solutions which would otherwise be unattainable with more primitive compliant or solid pin designs.

The plated through requirement of the C-Press[®] contact is easily achievable in production for printed circuit manufacturers. The C-Press[®] hole (see diagram) is the same as called out in MIL-STD-2166.

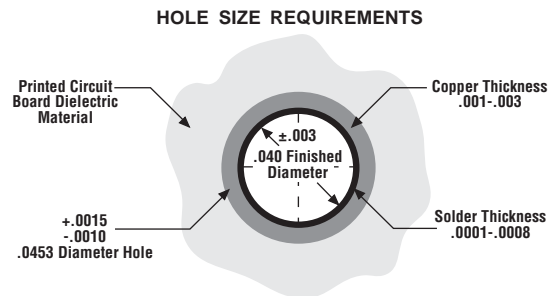

Standard Diameter P.T.H.

1. Hole drilled to .0453 +.0015, -.001 diameter.
2. Plating thickness must be .001 to .003 copper and .0001 to .0008 solder.
3. Final hole dimension must be gauged to .040 ±.003 diameter.
4. See Winchester drawing number 27331

Design Flexibility

For design flexibility across the board, the C-Press[®] contact gives you everything you need. As you go through the pages of this catalog you will find: *Pre-assembled Edgecard Connectors*, a variety of *Signal Pins*, *D-Subminiatures*, *MIL-C-83503 Headers*, *C-Tel[®]*, *Power Terminals*, *Strip Headers*, *DIN Connectors*, and more. With such a broad line of connectors, solder and press-fit technologies no longer need to be mixed on your backplane, thereby reducing assembly costs and production time. Over the years, billions of C-Press[®] contacts have been successfully installed by communications, computer and medical equipment manufacturers, as well as backpanel suppliers worldwide.

E.S.P. ... your global one-stop source for HD Plus Systems

Litton Electronic System Packaging is your early involvement technical marketing partner that facilitates the resources of Advanced Circuitry, Winchester Electronics, Inter-Pak Electronics and Interconnection Products-Scotland. ESP coordinates the total design, manufacture, assembly and test of your sub-system ... electronic packaging solutions.

Winchester Electronics

Winchester Electronics has provided more than four decades of innovative leadership in connector technology. The C-Press® contact offers the industry standard in compliant pin press-fit connector technology. It is specified in the most discriminating computer and telecommunications applications requiring long life and minimum hole distortion characteristics.

- HIGH DENSITY PLUS®
- Din Connectors
- C-Press® Compliant Pin
- RF Connectors
- Cable Assemblies
- Edgecard
- Rack and Panel
- L-Series
- 2 mm
- ISO-9002 Registered

Advanced Circuitry

Advanced Circuitry manufactures high density controlled impedance multilayer daughtercards and bare board backpanels.

- High Performance Substrates
- Large Panel Capability: Up to 30" x 48"
- PCB Thickness: Up to .400"
- Heat Sink Copper to 29 oz.
- Copper Inner Layers, UL Approved to 10 oz.
- Internal Reliability Lab
- Up to 50 layers... standard production
- ISO-9002 Registered

Inter-Pak Electronics

Inter-Pak Electronics is the benchmark supplier for automated press-fit backpanel assembly and advanced electrical test.

- Computer Controlled Automated Assembly
- Advanced Electrical System Test and Signal Analysis Level I, II, III and IV
- Custom Card Cage and Chassis Integration
- Solder Technology Center (SMT and Thru-Hole)
- ISO-9002 Registered

Interconnection Products Division (IPD)

IPD is a major supplier of backplane interconnection to the European marketplace.

- Backplane Interconnection Systems
- Sub-System Integration
- Computer Aided Backplane Engineering (CABE)
- ISO-9002 Registered

Other Product Offerings

Press-fit "SMA"
Coaxial Connector with
C-Press® compliant pin
technology

**The perfect
solderless
connector**

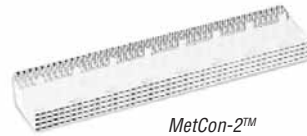

MetCon-2™
Connector System



Winchester
L-Series
High Density
two piece connector system



DIN 41612
Connector
System

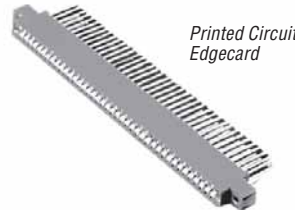

Printed Circuit
Edgcard



MIL-C-55302
military PCB interconnections

HIGH DENSITY PLUS®
pin and socket
interconnection
system

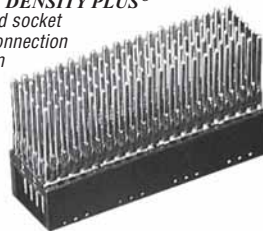

USECO Terminals
and Hardware

About Us

Winchester Electronics, a member of Litton Industries' Electronic Components and Materials group, has been a high reliability supplier of multipole electrical and electronic connectors since 1941. Through the years, Winchester has developed Rack and Panel, Cardedge and Military connectors for many diverse applications. Winchester's C-Press® compliant pin product has made us the favored supplier of the telecommunications and communications industries. We have led the industry in the use of DIN, HD+®, IDC, L-Series and other high density solder and press-fit connectors. Our products are installed in the backpanels and daughtercards of all major systems suppliers. To expand our product offering, Winchester recently acquired Retconn, a leading designer and manufacturer of RF coaxial connectors, contacts and cable harnesses for the communication and computer industries.

We are a company of many "FIRSTS":

- The First MIL-Grade Mono-Block Connector
- The First Quick-Disconnect Connector
- The First Pin and Socket Printed Circuit Connector
- The First Environmental Rectangular Connector
- The First Compliant Pin Connector

These "FIRSTS" were used on numerous Military programs such as Atlas, Titan, Minuteman, Polaris, Poseidon, Pershing and Bulpup, plus the F104, F105 and B-52, as well as Singars and Lantirn. These "Firsts" were also used in the initial backpanels made by Western Electric in their D4 channel banks and Bellpac (now Fastec) systems.

Winchester's core capabilities include high-speed, fine pitch, progressive stamping; precision molding; flexible rapid response development engineering; and high-volume assembly of connectors and cable assemblies, as well as contract manufacturing.

Winchester has several ISO 9000 registered production facilities all over the world. Sales efforts are global via direct salesman, Litton Precision Product International (LPPI) sales offices, contracted manufacturer's representatives and authorized distributors.

We are a member of Electronic Systems Packaging (ESP); Litton's system focused technical sales and marketing service. The other member divisions are Advanced Circuitry, Inter-Pak Electronics and Interconnection Products. ESP capitalizes on the synergy of our divisions to bring customers the most reliable, cost-effective custom backpanels and enhanced interconnect system packaging in the industry.

Winchester Electronics is committed to remain a World-Class supplier with products and services that meet clearly defined customer requirements **ON TIME, EVERY TIME.**

Winchester Electronics

62 Barnes Industrial Road North, Wallingford, Connecticut 06492 Phone:(203)741-5400 Fax:(203)741-5500 www.winchesterelectronics.com