

- 50 Ohm & 75 Ohm versions available.
- Miniature size connector with threaded coupling.
- Withstands shock & vibration, ideal for harsh environments.
- Keyed versions available to prevent mismatching and misalignment in critical applications.
- Commercial and Military-Specified versions available.
- Frequency Range: Up to 11 GHz

Specification

MATERIAL

Body:	Brass
Crimp Sleeves:	Commercial Bronze Alloy
Center Contacts:	Brass (Male) Beryllium Copper (Female)
Outer Contacts:	Beryllium Copper (Male)
Insulators: Gaskets & Seals:	PTFE Silicone Rubber

FINISHES

Body:	Silver or Nickel
Center Contacts:	Gold

ELECTRICAL

Impedance:	50 Ohms or 75 Ohms
Frequency Range:	DC to 11 GHz
Voltage Rating:	500 Volts RMS
VSWR:	1.30 Max, DC to 11 GHz .18
Insertion Loss:	dB Max at 9 GHz

MECHANICAL

Life:	500 Cycles
Cable Retention:	40 Pounds Minimum

ENVIRONMENTAL

Temperature Range:	-65° C to +165° C
Vibration:	MIL-STD-202, Method 204, Condition B
Shock:	MIL-STD-202, Method 213, Condition I
Corrosion:	MIL-STD-202, Method 101, Condition B
Moisture Resistance:	MIL-STD-202, Method 106

Interface Dimensions

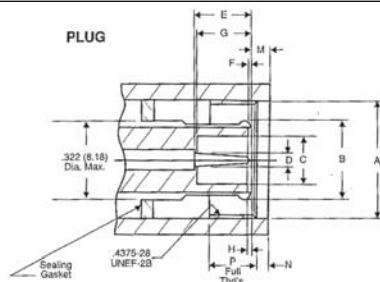

Dim Ltr	Inches (mm)		Dim Ltr	Inches (mm)	
	Minimum	Maximum		Minimum	Maximum
A	.440 (11.18)		G	.208 (5.28)	.228 (5.79)
B	Gauge Test		H	.003 (0.08)	.040 (1.02)
C	.190 (4.83)		M		.078 (1.98)
D	.052 (1.32)	.054 (1.37)	N	.063 (1.60)	
E	.210 (5.33)	.230 (5.84)	P	.156 (3.96)	
F	.006 (0.15)				

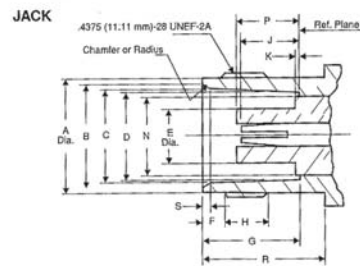

Dim Ltr	Inches (mm)		Dim Ltr	Inches (mm)	
	Minimum	Maximum		Minimum	Maximum
A	.378 (9.60)	.381 (9.68)	H	.187 (4.75)	
B	.346 (8.79)	.356 (9.04)	J	.186 (4.72)	.206 (5.23)
C	.327 (8.31)	.333 (8.46)	K		.006 (0.15)
D	.319 (8.10)	.321 (8.15)	N		.256 (6.50)
E		.186 (4.72)	P	.188 (4.78)	.208 (5.28)
F	.068 (1.73)	.088 (2.24)	R	.414 (10.52)	
G	.327 (8.31)	.335 (8.51)	S	.015 (0.38)	.030 (0.76)

Jack - Conventional

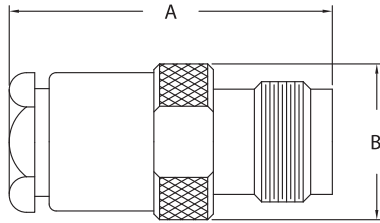

Figure 1

Panel Jack - Conventional

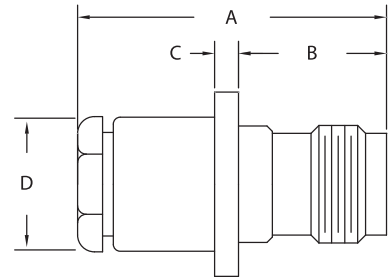

Figure 2

Jacks - K-Grip, JR.

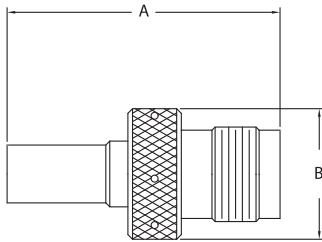

Figure 3

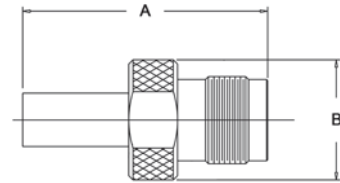

Figure 4

Item Number	Military PN	Product Description	Gender	Finish	Dimensions				Cable Group	Cable Procedure	Crimp Die	Mounting Hole	Figure #
					A	B	C	D					
KA-39-87	M39012/27-0101	Jack, Conventional	F	Silver	1.150	0.560			DE	CP-1050		1	
121-25-5		Jack, Conventional, Panel	F	Silver	1.250	0.560	0.090	0.500	3	CP-1050	*	2	
KA-19-181	M39012/29-0018	Jack, Conventional, Panel	F	Silver	1.150	0.550	0.090	0.500	B1	CP-1050	*	2	
KA-19-176	M39012/29-0101	Jack, Conventional, Panel	F	Silver	1.150	0.550	0.090	0.500	DE	CP-1050	*	2	
2431-78-10		Jack, Conventional, Panel, Keyed	F		1.160	1.000	0.090	0.210		3-355		N/S	
2431-78-5		Jack, Conventional, Panel, Keyed	F		1.160	1.000	0.090	0.210		3-355		N/S	
123-22-5		Jack, Crimp, Weatherproof	F	Silver	1.170	0.580			16	3-546-1	KTH-2121	3	
123-23-9		Jack, Crimp, Weatherproof	F	Nickel	1.720	0.590			18	3-546-2	KTH-2212	3	
123-27-9		Jack, Crimp, Weatherproof	F	Nickel	1.800	0.730			20	3-546-2	KTH-2229	3	
KA-39-82		Jack, Crimp, Weatherproof	F	Nickel	1.200	0.580			D	CP-5401	KTH-2061	3	
KA-39-85		Jack, Crimp, Weatherproof	F	Nickel	1.200	0.560			E1	CP-5401	KTH-2061	3	
KA-39-100 M06		Jack, Crimp, Weatherproof	F	Nickel	1.810	0.500			N3	CP-5402	KTH-2105	3	
KA-39-79	M39012/27-0503	Jack, Crimp	F	Silver	1.180	0.580			E1	CP-465	KTH-2001	4	
KA-39-76	M39012/27-0504	Jack, Crimp	F	Silver	1.170	0.560			D	CP-465	KTH-2001	4	

*Please Contact Customer Service for Additional Information

Bulkhead Jack – Conventional

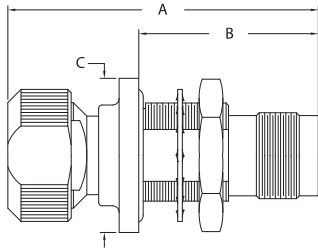

Figure 5

Angle Jack – K-Grip, JR.

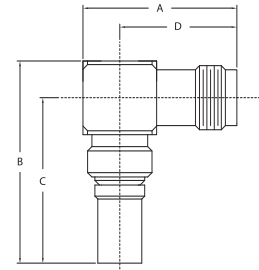

Figure 6

Bulkhead Jacks – K-Grip, JR.

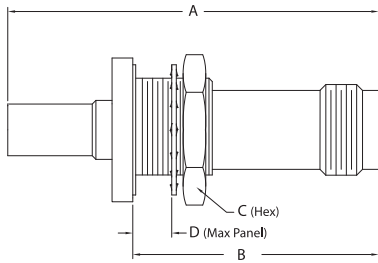

Figure 7

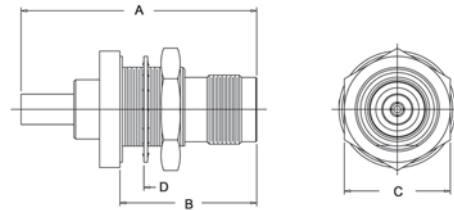

Figure 8

Item Number	Military PN	Product Description	Gender	Finish	Dimensions				Cable Group	Cable Procedure	Crimp Die	Mounting Hole	Figure #
					A	B	C	D					
KA-11-07		Jack, Conventional, Bulkhd	F		1.580	0.220				CP-1006	X	5	
KA-19-142		Jack, Conventional, Bulkhd	F	Nickel	1.470	0.860	0.730		B1	CP-1004.1		5	
122-32-5	M39012/28-0018	Jack, Conventional, Bulkhd	F	Silver	1.250	0.810	0.690		B1	3-527	X	5	
122-50-5		Jack, Conventional, Bulkhd	F	Silver	1.250	0.810	0.690		B1	3-527	X	5	
KA-19-171	M39012/28-0018	Jack, Conventional, Bulkhd	F	Silver	1.150	0.810	0.690		B1	CP-1050	X	5	
KA-19-19	M39012/28-0101	Jack, Conventional, Bulkhd	F	Silver	1.150	0.810	0.690		D	CP-1004	X	5	
122-27-5	M39012/28-0101	Jack, Conventional, Bulkhd	F	Silver	1.250	0.810	0.690		E1	3-526	X	5	
KA-19-172	M39012/28-0102	Jack, Conventional, Bulkhd	F	Silver	1.160	0.690	0.260		G	CP-1050	X	5	
123-24-9		Jack, Crimp, Angle, Weatherproof	F	Nickel	1.050	1.370	1.100	0.800	17	3-546-1	KTH-2216		6
123-28-9		Jack, Crimp, Angle, Weatherproof	F	Nickel	1.050	1.930	1.680	0.800	20	3-546-2	KTH-2229		6
122-37-9		Jack, Crimp, Bulkhd	F	Nickel	1.780	1.180	0.690		16	3-546-1	KTH-2161	X	7
122-3-5	M39012/28-0022	Jack, Crimp, Bulkhd	F	Silver	1.620	0.810	0.690		B1	CP-465	KTH-2011	X	7
122-55-9		Jack, Crimp, Bulkhd	F	Nickel	1.490	0.810	0.630	0.242	B1	3-646	KTH-2021	X	8
KA-19-42		Jack, Crimp, Bulkhd	F	Silver	1.390	0.800	0.630	0.242	B1	CP-407	KTH-2032	X	8
KA-19-60		Jack, Crimp, Bulkhd	F	Nickel	1.390	0.800	0.630	0.242	B1	CP-407	KTH-2032	X	8
KA-19-151	M39012/28-0502	Jack, Crimp, Bulkhd	F	Silver	1.400	0.810	0.630	0.241	C2	CP-465	KTH-2007	X	8
KA-19-101	M39012/28-0010	Jack, Crimp, Bulkhd	F	Silver	1.550	0.810	0.630	0.241	D	CP-465	KTH-2001	X	8
KA-19-153	M39012/28-0504	Jack, Crimp, Bulkhd	F	Silver	1.400	0.810	0.630	0.241	D	CP-465	KTH-2001	X	8
KA-19-102	M39012/28-0011	Jack, Crimp, Bulkhd	F	Silver	1.550	0.810	0.630	0.241	E1	CP-465	KTH-2001	X	8
KA-19-152	M39012/28-0503	Jack, Crimp, Bulkhd	F	Silver	1.400	0.810	0.630	0.241	E1	CP-465	KTH-2001	X	8
KA-19-146	M39012/28-0021	Jack, Crimp, Bulkhd	F	Silver	1.550	0.810	0.630	0.241	H	CP-465	KTH-2002	X	8

Angle Panel Jack – K-Grip, JR.

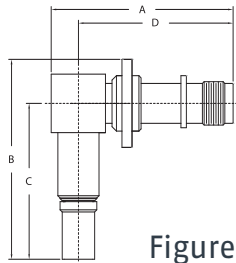

Figure 9

Panel Jack – K-Grip

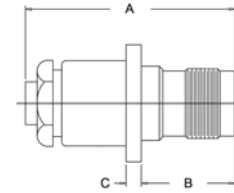

Figure 10

Panel Jacks – K-Grip, JR.

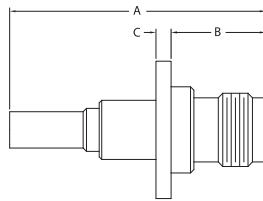

Figure 11

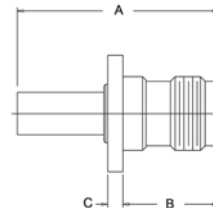

Figure 12

Item Number	Military PN	Product Description	Gender	Finish	Dimensions				Cable Group	Cable Procedure	Crimp Die	Mounting Hole	Figure #
					A	B	C	D					
2430-2-16		Jack, Crimp, Angle, Panel, Weatherproof	F	Nickel	1.670	1.840	1.430	1.420	17	3-546-2	KTH-2216	*	9
KA-19-25		Jack, Crimp, Panel	F	Silver	1.240	0.640	0.090		D	CP-201A	KTH-2001	*	10
KA-19-51		Jack, Crimp, Panel	F	Silver	1.240	0.640	0.090		D	CP-201A	KTH-2001	*	10
KA-39-93 M07		Jack, Crimp, Panel, Tee	F	Silver	2.080	0.720	1.800			3-86	KTH-2024		N/S
121-11-9		Jack, Crimp, Panel	F	Nickel	1.330	0.560	0.080		A	CP-1901	KTH-2008	*	N/S
611-1-9		75 Ohm, Jack, Crimp, Panel, W/P	F	Nickel	1.590	0.651	0.089		B2	3-661-4	KTH-2277	*	11
KA-19-195 M06		Jack, Crimp, Panel, W/P	F	Nickel	1.810	0.560	0.090		2	CP-480	KTH-1079	*	11
121-35-9		Jack, Crimp, Panel, W/P	F	Nickel	1.520	0.560	0.090		15	3-546-1	KTH-2214	*	11
121-36-9		Jack, Crimp, Panel, W/P	F	Nickel	1.400	0.560	0.090		16	3-546-1	KTH-2161	*	11
121-44-9		Jack, Crimp, Panel, W/P	F	Nickel	1.400	0.560	0.090		16	3-546-1	KTH-2161	*	11
2431-84-6		Jack, Crimp, Panel, W/P, Keyed	F	Nickel	1.520	0.930	0.090		16	3-546-1	KTH-2161	*	11
121-39-7		Jack, Crimp, Panel, W/P	F	Nickel	1.430	0.560	0.090		17	3-546-1	KTH-2216	*	11
121-39-9		Jack, Crimp, Panel, W/P	F	Nickel	1.430	0.560	0.090		17	3-546-1	KTH-2216	*	11
121-46-9		Jack, Crimp, Panel, W/P	F	Nickel	1.430	0.560	0.090		17	3-546-1	KTH-2216	*	11
121-38-9		Jack, Crimp, Panel, W/P	F	Nickel	1.800	0.560	0.090		19	3-546-2	KTH-2213	*	11
KA-19-143		Jack, Crimp, Panel, W/P	F	Nickel	1.440	0.560	0.090		D	CP-5401	KTH-2061	*	11
KA-19-216 M06		Jack, Crimp, Panel, W/P	F	Nickel	1.180	0.560	0.090		E1	CP-5401	KTH-2061	*	11
KA-19-213 M06		Jack, Crimp, Panel, W/P	F	Nickel	1.810	0.560	0.090		N3	CP-5402	KTH-2105	*	11
KA-19-198 M06		Jack, Crimp, Panel, W/P	F	Nickel	1.440	0.560	0.090			CP-5401	KTH-2128	*	11
KA-19-83		Jack, Crimp, Panel, W/P	F	Nickel	1.410	0.560	0.090		45	CP-5041	KTH-2161	*	11
121-52-9		Jack, Crimp, Panel, Iso Grnd, W/P	F	Nickel	1.520	0.790	0.090		15	3-546-1	KTH-2214	*	11
121-40-9		Jack, Crimp, Panel, Iso Grnd, W/P	F	Nickel	1.410	0.790	0.090		16	3-546-1	KTH-2161	*	11
121-37-9		Jack, Crimp, Panel, W/P	F	Nickel	1.710	0.560	0.090		18	3-546-2	KTH-2212	*	12
121-45-9		Jack, Crimp, Panel, W/P	F	Nickel	1.710	0.560	0.090		18	3-546-2	KTH-2212	*	12
KA-19-214	M39012/29-0022	Jack, Crimp, Panel	F	Silver	1.310	0.560	0.090		B1	CP-465	KTH-2011	*	12
KA-19-155	M39012/29-0502	Jack, Crimp, Panel	F	Silver	1.180	0.560	0.090		C2	CP-465	KTH-2007	*	12
KA-19-157	M39012/29-0504	Jack, Crimp, Panel	F	Silver	1.180	0.560	0.090		D	CP-465	KTH-2001	*	12
KA-19-156	M39012/29-0503	Jack, Crimp, Panel	F	Silver	1.180	0.560	0.090		E1	CP-465	KTH-2001	*	12
KA-19-110	M39012/29-0014	Jack, Crimp, Panel	F	Silver	1.410	0.260			G2	CP-465	KTH-2002	*	12

*Please Contact Customer Service for Additional Information

Keyed Panel Jack – K-Grip, JR.

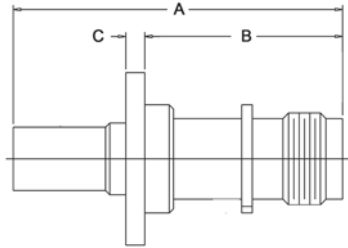

Figure 13

Item Number	Military PN	Product Description	Gender	Finish	Dimensions				Cable Group	Cable Procedure	Crimp Die	Mounting Hole	Figure #
					A	B	C	D					
2431-76-1		Jack, Crimp, Panel, W/P, Keyed	F	Nickel	2.030	0.930	0.090		2	CP-5402	KTH-1079	*	13
2431-76-11		Jack, Crimp, Panel, W/P, Keyed	F	Nickel	2.030	0.930	0.090		2	CP-5402	KTH-1079	*	13
2431-76-16		Jack, Crimp, Panel, W/P, Keyed	F	Nickel	2.030	0.930	0.090		2	CP-5402	KTH-1079	*	13
2431-76-6		Jack, Crimp, Panel, W/P, Keyed	F	Nickel	2.030	0.930	0.090		2	CP-5402	KTH-1079	*	13
2431-81-1		Jack, Crimp, Panel, W/P, Keyed	F	Nickel	1.550	0.930	0.090		15	3-546-1	KTH-2214	*	13
2431-81-11		Jack, Crimp, Panel, W/P, Keyed	F	Nickel	1.550	0.930	0.090		15	3-546-1	KTH-2214	*	13
2431-81-16		Jack, Crimp, Panel, W/P, Keyed	F	Nickel	1.550	0.930	0.090		15	3-546-1	KTH-2214	*	13
2431-81-2		Jack, Crimp, Panel, W/P, Keyed	F	Nickel	1.550	0.930	0.090		15	3-546-1	KTH-2214	*	13
2431-81-6		Jack, Crimp, Panel, W/P, Keyed	F	Nickel	1.550	0.930	0.090		15	3-546-1	KTH-2214	*	13
2431-81-9		Jack, Crimp, Panel, W/P, Keyed	F	Nickel	1.550	0.930	0.090		15	3-546-1	KTH-2214	*	13
2431-80-1		Jack, Crimp, Panel, W/P, Keyed	F	Nickel	1.520	0.930	0.090		16	3-546-1	KTH-2161	*	13
2431-80-11		Jack, Crimp, Panel, W/P, Keyed	F	Nickel	1.520	0.930	0.090		16	3-546-1	KTH-2161	*	13
2431-80-16		Jack, Crimp, Panel, W/P, Keyed	F	Nickel	1.520	0.930	0.090		16	3-546-1	KTH-2161	*	13
2431-80-20		Jack, Crimp, Panel, W/P, Keyed	F	Nickel	1.520	0.930	0.090		16	3-546-1	KTH-2161	*	13
2431-80-6		Jack, Crimp, Panel, W/P, Keyed	F	Nickel	1.520	0.930	0.090		16	3-546-1	KTH-2161	*	13
2431-84-1		Jack, Crimp, Panel, W/P, Keyed	F	Nickel	1.520	0.930	0.090		16	3-546-1	KTH-2161	*	13
2431-84-11		Jack, Crimp, Panel, W/P, Keyed	F	Nickel	1.520	0.930	0.090		16	3-546-1	KTH-2161	*	13
2431-84-16		Jack, Crimp, Panel, W/P, Keyed	F	Nickel	1.520	0.930	0.090		16	3-546-1	KTH-2161	*	13
2431-84-2		Jack, Crimp, Panel, W/P, Keyed	F	Nickel	1.520	0.930	0.090		16	3-546-1	KTH-2161	*	13
2431-84-5		Jack, Crimp, Panel, W/P, Keyed	F	Nickel	1.520	0.930	0.090		16	3-546-1	KTH-2161	*	13
2431-85-1		Jack, Crimp, Panel, W/P, Keyed	F	Nickel	1.550	0.930	0.090		17	3-546-1	KTH-2216	*	13
2431-85-11		Jack, Crimp, Panel, W/P, Keyed	F	Nickel	1.550	0.930	0.090		17	3-546-1	KTH-2216	*	13
2431-85-16		Jack, Crimp, Panel, W/P, Keyed	F	Nickel	1.550	0.930	0.090		17	3-546-1	KTH-2216	*	13
2431-85-6		Jack, Crimp, Panel, W/P, Keyed	F	Nickel	1.550	0.930	0.090		17	3-546-1	KTH-2216	*	13
2431-87-1		Jack, Crimp, Panel, W/P, Keyed	F	Nickel	1.550	0.930	0.090		17	3-546-1	KTH-2216	*	13

*Please Contact Customer Service for Additional Information

Item Number	Military PN	Product Description	Gender	Finish	Dimensions				Cable Group	Cable Procedure	Crimp Die	Mounting Hole	Figure #
					A	B	C	D					
2431-87-11		Jack, Crimp, Panel, W/P, Keyed	F	Nickel	1.550	0.930	0.090		17	3-546-1	KTH-2216	*	13
2431-87-16		Jack, Crimp, Panel, W/P, Keyed	F	Nickel	1.550	0.930	0.090		17	3-546-1	KTH-2216	*	13
2431-87-3		Jack, Crimp, Panel, W/P, Keyed	F	Nickel	1.550	0.930	0.090		17	3-546-1	KTH-2216	*	13
2431-87-6		Jack, Crimp, Panel, W/P, Keyed	F	Nickel	1.550	0.930	0.090		17	3-546-1	KTH-2216	*	13
2431-83-1		Jack, Crimp, Panel, W/P, Keyed	F	Nickel	1.930	0.930	0.090		18	3-546-2	KTH-2212	*	13
2431-83-11		Jack, Crimp, Panel, W/P, Keyed	F	Nickel	1.930	0.930	0.090		18	3-546-2	KTH-2212	*	13
2431-83-16		Jack, Crimp, Panel, W/P, Keyed	F	Nickel	1.930	0.930	0.090		18	3-546-2	KTH-2212	*	13
2431-88-1		Jack, Crimp, Panel, W/P, Keyed	F	Nickel	1.930	0.930	0.090		18	3-546-2	KTH-2212	*	13
2431-88-11		Jack, Crimp, Panel, W/P, Keyed	F	Nickel	1.930	0.930	0.090		18	3-546-2	KTH-2212	*	13
2431-88-16		Jack, Crimp, Panel, W/P, Keyed	F	Nickel	1.930	0.930	0.090		18	3-546-2	KTH-2212	*	13
2431-88-6		Jack, Crimp, Panel, W/P, Keyed	F	Nickel	1.930	0.930	0.090		18	3-546-2	KTH-2212	*	13
2431-89-1		Jack, Crimp, Panel, W/P, Keyed	F	Nickel	2.030	0.930	0.090		19	3-546-2	KTH-2213	*	13
2431-89-11		Jack, Crimp, Panel, W/P, Keyed	F	Nickel	2.030	0.930	0.090		19	3-546-2	KTH-2213	*	13
2431-89-16		Jack, Crimp, Panel, W/P, Keyed	F	Nickel	2.030	0.930	0.090		19	3-546-2	KTH-2213	*	13
2431-89-6		Jack, Crimp, Panel, W/P, Keyed	F	Nickel	2.030	0.930	0.090		19	3-546-2	KTH-2213	*	13
2431-74-1		Jack, Crimp, Panel, W/P, Keyed	F	Nickel	1.520	0.930	0.090		1	CP-465	KTH-2061	*	13
2431-74-11		Jack, Crimp, Panel, W/P, Keyed	F	Nickel	1.520	0.930	0.090		1	CP-465	KTH-2061	*	13
2431-74-16		Jack, Crimp, Panel, W/P, Keyed	F	Nickel	1.520	0.930	0.090		1	CP-465	KTH-2061	*	13
2431-74-2		Jack, Crimp, Panel, W/P, Keyed	F	Nickel	1.520	0.930	0.090		1	CP-465	KTH-2061	*	13
2431-74-3		Jack, Crimp, Panel, W/P, Keyed	F	Nickel	1.520	0.930	0.090		1	CP-465	KTH-2061	*	13
2431-74-4		Jack, Crimp, Panel, W/P, Keyed	F	Nickel	1.520	0.930	0.090		1	CP-465	KTH-2061	*	13
2431-74-6		Jack, Crimp, Panel, W/P, Keyed	F	Nickel	1.520	0.930	0.090		1	CP-465	KTH-2061	*	13
2431-90-1		Jack, Crimp, Panel, W/P, Keyed	F	Nickel	1.460	0.930	0.090		B1	3-546-8	KTH-2081	*	13
2431-90-11		Jack, Crimp, Panel, W/P, Keyed	F	Nickel	1.460	0.930	0.090		B1	3-546-8	KTH-2081	*	13
2431-90-16		Jack, Crimp, Panel, W/P, Keyed	F	Nickel	1.460	0.930	0.090		B1	3-546-8	KTH-2081	*	13
2431-90-6		Jack, Crimp, Panel, W/P, Keyed	F	Nickel	1.460	0.930	0.090		B1	3-546-8	KTH-2081	*	13
2431-91-1		Jack, Crimp, Panel, W/P, Keyed	F	Nickel	1.550	0.930	0.090		89	3-546-1	KTH-2062	*	13
2431-91-11		Jack, Crimp, Panel, W/P, Keyed	F	Nickel	1.550	0.930	0.090		89	3-546-1	KTH-2062	*	13
2431-91-6		Jack, Crimp, Panel, W/P, Keyed	F	Nickel	1.550	0.930	0.090		89	3-546-1	KTH-2062	*	13
2431-82-1		Jack, Crimp, Panel, Iso Grnd, W/P, Keyed	F	Nickel	1.720	1.130	0.090		16	3-546-1	KTH-2161	*	13
2431-82-11		Jack, Crimp, Panel, Iso Grnd, W/P, Keyed	F	Nickel	1.720	1.130	0.090		16	3-546-1	KTH-2161	*	13
2431-82-16		Jack, Crimp, Panel, Iso Grnd, W/P, Keyed	F	Nickel	1.720	1.130	0.090		16	3-546-1	KTH-2161	*	13
2431-82-2		Jack, Crimp, Panel, Iso Grnd, W/P, Keyed	F	Nickel	1.720	1.130	0.090		16	3-546-1	KTH-2161	*	13
2431-82-5		Jack, Crimp, Panel, Iso Grnd, W/P, Keyed	F	Nickel	1.720	1.130	0.090		16	3-546-1	KTH-2161	*	13
2431-82-6		Jack, Crimp, Panel, Iso Grnd, W/P, Keyed	F	Nickel	1.720	1.130	0.090		16	3-546-1	KTH-2161	*	13

*Please Contact Customer Service for Additional Information

Angle Plugs - K-Grip, JR.

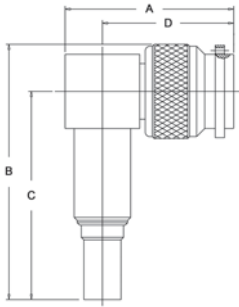

Figure 14

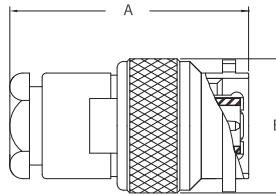

Figure 15

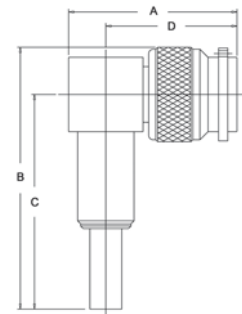

Figure 16

Item Number	Military PN	Product Description	Gender	Finish	Dimensions				Cable Group	Cable Procedure	Crimp Die	Mounting Hole	Figure #
					A	B	C	D					
KA-59-189		Plug, Crimp, Angle, W/P	M	Nickel	1.130	1.730	0.640	0.890	45	CP-5401	KTH-2161		14
KA-59-186		Plug, Crimp, Angle, W/P	M	Nickel	1.190	1.900	1.590	0.880	2	CP-5402	KTH-1079		14
126-35-9		Plug, Crimp, Angle, W/P	M	Nickel	1.190	1.870	1.550	0.880	8	3-440-2	KTH-1077		14
126-58-9		Plug, Crimp, Angle, W/P, Hex Nut	M	Nickel	1.130	1.740	1.420	0.880	16	3-546-1	KTH-2161		14
126-71-7		Plug, Crimp, Angle, W/P	M	Nickel	1.130	1.770	1.450	0.880	17	3-546-1	KTH-2216		14
126-71-9		Plug, Crimp, Angle, W/P, Hex Clpg Nut	M	Nickel	1.130	1.770	1.450	0.880	17	3-546-1	KTH-2216		14
126-59-9		Plug, Crimp, Angle, W/P	M	Nickel	1.190	1.870	1.550	0.880	18	3-546-2	KTH-2212		14
126-70-9		Plug, Crimp, Angle, W/P	M	Nickel	3.050	1.810	1.500	2.740	18	3-546-2	KTH-2212		14
126-85-9		Plug, Crimp, Angle, W/P	M	Nickel	1.220	1.920	1.550	0.880	18	3-546-2	KTH-2212		14
126-73-9		Plug, Crimp, Angle, W/P	M	Nickel	1.190	1.960	1.640	0.880	19	3-546-2	KTH-2213		14
126-74-9		Plug, Crimp, Angle, W/P	M	Nickel	1.190	1.960	1.640	0.880	20	3-546-2	KTH-2229		14
KA-59-304		Plug, Crimp, Angle, W/P	M	Nickel	1.130	1.820	1.450	0.890	D	CP-5401	KTH-2061		14
KA-59-439 M06		Plug, Crimp, Angle, W/P	M	Nickel	1.120	1.740	1.420	0.880	E1	CP-5401	KTH-2061		14
126-63-9		Plug, Crimp, Angle, W/P	M	Nickel	1.130	1.740	1.420	0.880	E1	CP-5402	KTH-2061		14
126-64-9		Plug, Crimp, Angle, W/P	M	Nickel	3.050	1.900	1.590	2.740	N3	CP-5402	KTH-2105		14
KA-59-138		Plug, Crimp, Angle	M	Silver	1.250	1.790	0.750	1.490	N1	CP-209A	KTH-2004		15
KA-59-318		Plug, Crimp, Angle	M	Silver	1.250	1.810	0.750	1.490	N1,P	CP-209A	KTH-2004		15
KA-59-96		Plug, Crimp, Angle	M	Nickel	1.220	1.810	0.750	1.490	N1	CP-209A	KTH-2004		15
KA-59-281		Plug, Angle, Preassembled	M	Silver	1.120	1.630	1.320	0.870	B	CP-465	KTH-2011		16
126-8-5	M39012/30-0022	Preassembled	M	Silver	1.120	1.630	1.320	0.870	B1	CP-465	KTH-2011		16
KA-59-70 M06		Plug, Crimp, Angle	M	Nickel	1.040	1.450	1.150	0.850	B1	CP-406	KTH-2032		16
KA-59-295	M39012/30-0502	Plug, Crimp, Angle	M	Silver	1.130	1.790	1.420	0.890	C2	CP-465	KTH-2007		16
KA-59-235	M39012/30-0010	Plug, Crimp, Angle	M	Silver	1.120	1.400	1.080	0.870	D	CP-465	KTH-2001		16
KA-59-297	M39012/30-0504	Plug, Crimp, Angle	M	Silver	1.130	1.790	1.420	0.890	D	CP-465	KTH-2001		16
126-79-5		Plug, Crimp, Angle	M	Silver	1.210	1.850	1.460	0.880	E1	CP-465	KTH-2001		16
KA-59-236	M39012/30-0011	Plug, Crimp, Angle	M	Silver	1.120	1.400	1.080	0.870	E1	CP-465	KTH-2001		16
KA-59-296	M39012/30-0503	Plug, Crimp, Angle	M	Silver	1.130	1.790	1.420	0.890	E1	CP-465	KTH-2001		16
KA-59-72		Plug, Crimp, Angle	M	Silver	1.040	1.630	1.340	0.850	E1	CP-401	KTH-2001		16
KA-59-237	M39012/30-0012	Plug, Crimp, Angle	M	Silver	1.120	1.400	1.080	0.870	G1	CP-465	KTH-2002		16
KA-59-208		Plug, Crimp, Angle	M	Nickel	1.110	1.690	1.390	0.840	M1	CP-416	KTH-2003		16
126-14-5		Plug, Crimp, Angle	M	Nickel	1.190	1.900	1.590	0.880	N3	CP-5402	KTH-2105		16
126-68-5		Plug, Crimp, Angle	M	Silver	1.210	1.870	1.420	0.690		CP-465	KTH-2001		16
126-12-5		Plug, Crimp, Angle	M	Silver	1.130	1.790	1.420	0.880		CP-465	KTH-2007		16
126-86-3		Plug, Crimp, Angle, Hex	M		1.120	1.740	1.420	0.880		CP-465	KTH-2007		16
126-69-5		Plug, Crimp, Angle	M	Silver	1.190	2.510	1.500	0.880		CP-5402	KTH-2012		16

Plugs – Conventional, K-Grip

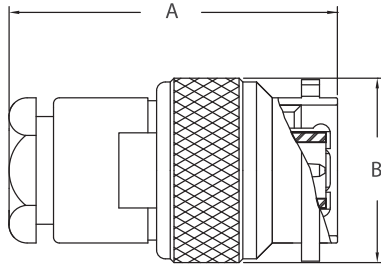

Figure 17

Angle Plug – Conventional

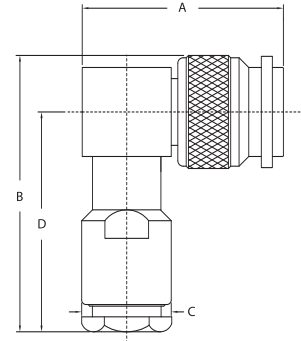

Figure 18

Attenuator

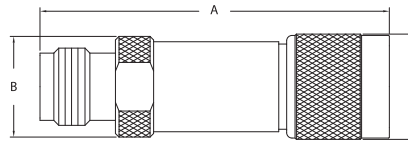

Figure 19

Item Number	Military PN	Product Description	Gender	Finish	Dimensions				Cable Group	Cable Procedure	Crimp Die	Mounting Hole	Figure #
					A	B	C	D					
KA-59-289	M39012/26-0013	Plug, Conventional	M	Silver	1.080	0.630			B1	CP-1050			17
KA-51-18		Plug, Conventional	M	Silver	1.090	0.590	0.590		DE	CP-1004			17
KA-59-22	M39012/26-0101	Plug, Conventional	M	Silver	1.080	0.630	0.630		DE	CP-1050			17
125-67-5	M39012/26-0101	Plug, Conventional	M	Silver	1.120	0.630			DE	CP-1050			17
KA-59-18	M39012/26-0102	Plug, Conventional	M	Silver	1.090	0.630			G1	CP-1050			17
KA-51-19		Plug, Conventional	M	Silver	1.670	0.590	0.590		MN	CP-1005			17
125-25-5		Plug, Conventional	M	Silver	1.090	0.640				CP-465			17
KA-59-29		Plug, Crimp	M	Silver	1.180	0.630			D	CP-201A	KTH-2001		17
KA-59-435		Plug, Crimp	M	Nickel	1.690	0.750			N1	CP-230A	KTH-2004		17
KA-59-146		Plug, Crimp	M	Silver	1.680	0.750			N3	CP-209A	KTH-2004		17
KA-59-267		Plug, Crimp	M	Silver	1.690	0.630			P	CP-230A	KTH-2004		17
KA-59-85 M07		Plug, Crimp, Angle, Hex Cplg Nut	M	Silver	1.490	1.250	0.750	0.560	K3	CP-209A	KTH-2012		17
KA-59-348	M39012/30-0118	Plug, Conventional, Angle	M	Silver	1.130	1.560	0.500	1.250	B1	CP-1050			18
KA-59-343	M39012/30-0101	Plug, Conventional, Angle	M	Silver	1.130	1.560	0.500	1.250	DE	CP-1050			18
126-55-5	M39012/30-0101	Plug, Conventional, Angle	M	Silver	1.218	1.750		1.330	DE	3-526			18
126-54-5	M39012/30-0102	Plug, Conventional, Angle	M	Silver	1.218	1.750	0.440	1.330	G1	3-526			18
1800-10		Attenuator	M-F	Nickel	1.950	0.560	0.590						19
1800-11		Attenuator	M-F	Nickel	1.950	0.560	0.590						19
1800-4		Attenuator	M-F	Nickel	1.950	0.560	0.590						19
1800-6		Attenuator	M-F	Nickel	1.950	0.560	0.590						19
1800-7		Attenuator	M-F	Nickel	1.950	0.560	0.590						19

Angle Plugs – K-Grip, JR., Keyed

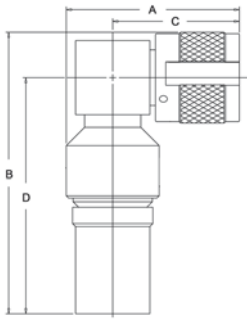

Figure 20

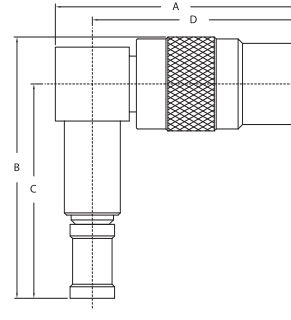

Figure 21

Plugs – K-Grip, JR., Keyed

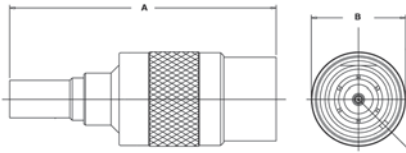

Figure 22

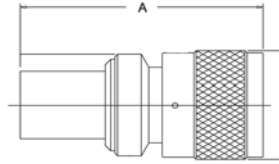

Figure 23

Item Number	Military PN	Product Description	Gender	Finish	Dimensions				Cable Group	Cable Procedure	Crimp Die	Mounting Hole	Figure #
					A	B	C	D					
KA-59-324		Plug, Crimp, Angle, W/P, Keyed	M	Silver	1.160	1.900	0.850	1.590	N3	CP-5402	KTH-2105		20
2436-80-1		Plug, Crimp, Angle, W/P, Keyed	M		1.550	1.760	1.450	1.300	1	CP-465	KTH-2061		21
2436-81-1		Plug, Crimp, Angle, W/P, Keyed	M	Nickel	1.600	1.740	1.410	1.350	16	3-546-1	KTH-2161		21
2436-81-11		Plug, Crimp, Angle, W/P, Keyed	M	Nickel	1.600	1.740	1.410	1.350	16	3-546-1	KTH-2161		21
2436-81-16		Plug, Crimp, Angle, W/P, Keyed	M	Nickel	1.600	1.740	1.410	1.350	16	3-546-1	KTH-2161		21
2436-81-2		Plug, Crimp, Angle, W/P, Keyed	M	Nickel	1.600	1.740	1.410	1.350	16	3-546-1	KTH-2161		21
2436-81-21		Plug, Crimp, Angle, W/P, Keyed	M	Nickel	1.600	1.740	1.410	1.350	16	3-546-1	KTH-2161		21
2436-81-6		Plug, Crimp, Angle, W/P, Keyed	M	Nickel	1.600	1.740	1.410	1.350	16	3-546-1	KTH-2161		21
2436-83-1		Plug, Crimp, Angle, W/P, Keyed	M	Nickel	1.660	1.870	1.550	1.350	18	3-546-2	KTH-2212		21
2436-83-11		Plug, Crimp, Angle, W/P, Keyed	M	Nickel	1.660	1.870	1.550	1.350	18	3-546-2	KTH-2212		21
2436-83-16		Plug, Crimp, Angle, W/P, Keyed	M	Nickel	1.660	1.870	1.550	1.350	18	3-546-2	KTH-2212		21
2436-83-24		Plug, Crimp, Angle, W/P, Keyed	M	Nickel	1.660	1.870	1.550	1.350	18	3-546-2	KTH-2212		21
2436-83-6		Plug, Crimp, Angle, W/P, Keyed	M	Nickel	1.660	1.870	1.550	1.350	18	3-546-2	KTH-2212		21
2436-83-9		Plug, Crimp, Angle, W/P, Keyed	M	Nickel	1.660	1.870	1.550	1.350	18	3-546-2	KTH-2212		21
2436-85-1		Plug, Crimp, Angle, W/P, Keyed	M	Nickel	1.660	1.930	1.640	1.350	19	3-546-2	KTH-2213		21
2436-85-6		Plug, Crimp, Angle, W/P, Keyed	M	Nickel	1.660	1.930	1.640	1.350	19	3-546-2	KTH-2213		21
2436-82-1		Plug, Crimp, Angle, W/P, Keyed	M	Silver	1.650	1.900	1.590	1.340	N3	CP-5402	KTH-2105		21
2436-82-10		Plug, Crimp, Angle, W/P, Keyed	M	Silver	1.650	1.900	1.590	1.340	N3	CP-5402	KTH-2105		21
2436-82-5		Plug, Crimp, Angle, W/P, Keyed	M	Silver	1.650	1.900	1.590	1.340	N3	CP-5402	KTH-2105		21
2436-6-3		Plug, Crimp, Angle, Keyed	M		1.540	1.740	1.420	1.290		CP-465	KTH-2007		N/S
126-1-2		Plug, Crimp, Angle, Keyed	M	Silver	1.210	2.000	1.420	0.850	E1	CP-465	KTH-2001		N/S
126-4-1		Plug, Crimp, Angle, Keyed	M	Silver	1.210	2.000	1.420	0.850	C2	CP-465	KTH-2007		N/S
2435-77-1		Plug, Crimp, W/P, Keyed	M	Nickel	2.220	0.640			2	CP-5402	KTH-1079		22
2435-77-11		Plug, Crimp, W/P, Keyed	M	Nickel	2.220	0.640			2	CP-5402	KTH-1079		22
2435-77-16		Plug, Crimp, W/P, Keyed	M	Nickel	2.220	0.640			2	CP-5402	KTH-1079		22
2435-77-6		Plug, Crimp, W/P, Keyed	M	Nickel	2.220	0.640			2	CP-5402	KTH-1079		22

Item Number	Military PN	Product Description	Gender	Finish	Dimensions				Cable Group	Cable Procedure	Crimp Die	Mounting Hole	Figure #
					A	B	C	D					
2435-82-1		Plug, Crimp, W/P, Keyed	M	Nickel	1.800	0.650			15	3-546-1	KTH-2214		22
2435-82-6		Plug, Crimp, W/P, Keyed	M	Nickel	1.800	0.650			15	3-546-1	KTH-2214		22
2435-81-1		Plug, Crimp, W/P, Keyed	M	Nickel	1.580	0.650			16	3-546-1	KTH-2161		22
2435-81-11		Plug, Crimp, W/P, Keyed	M	Nickel	1.580	0.650			16	3-546-1	KTH-2161		22
2435-81-16		Plug, Crimp, W/P, Keyed	M	Nickel	1.580	0.650			16	3-546-1	KTH-2161		22
2435-81-2		Plug, Crimp, W/P, Keyed	M	Nickel	1.580	0.650			16	3-546-1	KTH-2161		22
2435-81-20		Plug, Crimp, W/P, Keyed	M	Nickel	1.580	0.650			16	3-546-1	KTH-2161		22
2435-81-5		Plug, Crimp, W/P, Keyed	M	Nickel	1.580	0.650			16	3-546-1	KTH-2161		22
2435-81-6		Plug, Crimp, W/P, Keyed	M	Nickel	1.580	0.650			16	3-546-1	KTH-2161		22
2435-81-9		Plug, Crimp, W/P, Keyed	M	Nickel	1.580	0.650			16	3-546-1	KTH-2161		22
2435-84-1		Plug, Crimp, Weatherproof, Keyed	M	Nickel	1.610	0.650			17	3-546-1	KTH-2216		22
2435-84-11		Plug, Crimp, Weatherproof, Keyed	M	Nickel	1.610	0.650			17	3-546-1	KTH-2216		22
2435-84-16		Plug, Crimp, Weatherproof, Keyed	M	Nickel	1.610	0.650			17	3-546-1	KTH-2216		22
2435-84-3		Plug, Crimp, Weatherproof, Keyed	M	Nickel	1.610	0.650			17	3-546-1	KTH-2216		22
2435-84-5		Plug, Crimp, Weatherproof, Keyed	M	Nickel	1.610	0.650			17	3-546-1	KTH-2216		22
2435-84-6		Plug, Crimp, Weatherproof, Keyed	M	Nickel	1.610	0.650			17	3-546-1	KTH-2216		22
2435-83-1		Plug, Crimp, Weatherproof, Keyed	M	Nickel	2.130	0.650			18	3-546-2	KTH-2212		22
2435-83-11		Plug, Crimp, Weatherproof, Keyed	M	Nickel	2.130	0.650			18	3-546-2	KTH-2212		22
2435-83-16		Plug, Crimp, Weatherproof, Keyed	M	Nickel	2.130	0.650			18	3-546-2	KTH-2212		22
2435-83-6		Plug, Crimp, Weatherproof, Keyed	M	Nickel	2.130	0.650			18	3-546-2	KTH-2212		22
2435-87-1		Plug, Crimp, Weatherproof, Keyed	M	Nickel	2.215	0.650			19	3-546-2	KTH-2213		22
2435-87-11		Plug, Crimp, Weatherproof, Keyed	M	Nickel	2.215	0.650			19	3-546-2	KTH-2213		22
2435-87-16		Plug, Crimp, Weatherproof, Keyed	M	Nickel	2.215	0.650			19	3-546-2	KTH-2213		22
2435-87-6		Plug, Crimp, Weatherproof, Keyed	M	Nickel	2.215	0.650			19	3-546-2	KTH-2213		22
2435-89-1		Plug, Crimp, Weatherproof, Keyed	M	Nickel	2.330	0.650			20	3-546-2	KTH-2229		22
2435-89-11		Plug, Crimp, Weatherproof, Keyed	M	Nickel	2.330	0.650			20	3-546-2	KTH-2229		22
2435-89-16		Plug, Crimp, Weatherproof, Keyed	M	Nickel	2.330	0.650			20	3-546-2	KTH-2229		22
2435-89-6		Plug, Crimp, Weatherproof, Keyed	M	Nickel	2.330	0.650			20	3-546-2	KTH-2229		22
2435-74-1		Plug, Crimp, Weatherproof, Keyed	M	Nickel	1.580	0.650			E1	CP-465	KTH-2061		22
2435-74-11		Plug, Crimp, Weatherproof, Keyed	M	Nickel	1.580	0.650			E1	CP-465	KTH-2061		22
2435-74-16		Plug, Crimp, Weatherproof, Keyed	M	Nickel	1.580	0.650			E1	CP-465	KTH-2061		22
2435-74-3		Plug, Crimp, Weatherproof, Keyed	M	Nickel	1.580	0.650			E1	CP-465	KTH-2061		22
2435-74-6		Plug, Crimp, Weatherproof, Keyed	M	Nickel	1.580	0.650			E1	CP-465	KTH-2061		22
2435-88-1		Plug, Crimp, W/P, Keyed	M	Nickel	1.580	0.640			89	3-440-3	KTH-2062		22
2435-88-11		Plug, Crimp, W/P, Keyed	M	Nickel	1.580	0.640			89	3-440-3	KTH-2062		22
2435-88-16		Plug, Crimp, W/P, Keyed	M	Nickel	1.580	0.640			89	3-440-3	KTH-2062		22
2435-88-6		Plug, Crimp, W/P, Keyed	M	Nickel	1.580	0.640			89	3-440-3	KTH-2062		22
125-4-1		Plug, Crimp, Keyed	M	Silver	1.500	0.610			C2	CP-465			N/S
125-4-2		Plug, Crimp, Keyed	M	Silver	1.500	0.610			C2	CP-465	KTH-2007		N/S
125-86-1		Plug, Crimp, Keyed	M	Silver	1.240	0.610			D	CP-465	KTH-2001		N/S
125-1-1		Plug, Crimp, Keyed	M	Silver	1.240	0.610			E1	CP-465	KTH-2001		N/S
125-1-6		Plug, Crimp, Keyed	M	Silver	1.500	0.610			E1	CP-465	KTH-2001		N/S
125-52-1		Plug, Crimp, Keyed	M	Silver	2.000	0.610			11	CP-5402	KTH-2012		23
125-52-2		Plug, Crimp, Keyed	M	Silver	2.000	0.610			11	CP-5402	KTH-2012		23
125-52-3		Plug, Crimp, Keyed	M	Silver	2.000	0.610			11	CP-5402	KTH-2012		23
125-52-4		Plug, Crimp, Keyed	M	Silver	2.000	0.610			11	CP-5402	KTH-2012		23

Plug - K-Grip, JR.

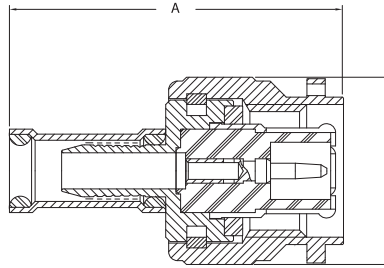

Figure 24

Item Number	Military PN	Product Description	Gender	Finish	Dimensions				Cable Group	Cable Procedure	Crimp Die	Mounting Hole	Figure #
					A	B	C	D					
KA-59-167		Plug, Crimp, W/P	M	Nickel	1.110	0.590					KTH-2062		24
KA-59-185		Plug, Crimp, W/P	M	Nickel	1.830	0.630			2	CP-5402	KTH-1079		24
KA-59-185 MC7		Plug, Crimp, W/P	M	Silver	1.830	0.630			2	CP-5402	KTH-1079		24
125-57-9		Plug, Crimp, W/P	M	Nickel	1.740	0.640			8	3-440-2	KTH-1077		24
125-58-9		Plug, Crimp, W/P	M	Nickel	1.140	0.640			10	3-440-3	KTH-2061		24
KA-59-391 M06		Plug, Crimp, W/P	M	Nickel	1.740	0.630			12	CP-5402	KTH-2127		24
125-89-9		Plug, Crimp, W/P	M	Nickel	1.330	0.560			15	3-546-1	KTH-2214		24
125-88-9		Plug, Crimp, W/P	M	Nickel	1.110	0.560			16	3-546-1	KTH-2161		24
125-94-9		Plug, Crimp, W/P	M	Gold	1.110	0.500			16	3-546-1	KTH-2161		24
125-95-7		Plug, Crimp, W/P	M	Nickel	1.140	0.640			17	3-546-1	KTH-2216		24
125-95-9		Plug, Crimp, W/P	M	Nickel	1.140	0.560			17	3-546-1	KTH-2216		24
125-96-9		Plug, Crimp, Weatherproof	M	Gold	1.140	0.500			17	3-546-1	KTH-2216		24
125-101-9		Plug, Crimp, Weatherproof	M	Nickel	1.660	0.560			18	3-546-2	KTH-2212		24
125-117-9		Plug, Crimp, Weatherproof	M	Nickel	1.660	0.760			18	3-546-2	KTH-2212		24
125-91-9		Plug, Crimp, Weatherproof	M	Nickel	1.690	0.560			18	3-546-2	KTH-2212		24
125-92-9		Plug, Crimp, Weatherproof	M	Nickel	2.000	0.640			19	3-546-2	KTH-2213		24
125-105-9		Plug, Crimp, Weatherproof	M	Nickel	1.840	0.640			20	3-546-2	KTH-2229		24
KA-59-260		Plug, Crimp, Weatherproof	M	Nickel	1.040	0.590			B1	CP-402	KTH-2081		24
615-11-9		Plug, Crimp, Weatherproof, 75 Ohm	M	Nickel	1.210	0.570			B2	3-661-4	KTH-2277		24
125-69-9		Plug, Crimp, Weatherproof	M	Nickel	1.110	0.640			C2	CP-5401	KTH-2067		24
KA-59-277		Plug, Crimp, Weatherproof	M	Nickel	1.140	0.630			D	CP-5401	KTH-2061		24
KA-59-438 M06		Plug, Crimp, W/P	M	Nickel	1.110	0.630			E1	CP-465	KTH-2061		24
KA-59-251		Plug, Crimp, W/P	M	Nickel	1.120	0.630			E1	CP-472	KTH-2061		24
125-98-9		Plug, Crimp, W/P, Hex Cplg Nut	M	Nickel	1.110	0.610			E1	CP-5401	KTH-2061		24
KA-59-353 M06		Plug, Crimp, W/P	M	Nickel	1.830	0.630			N3	CP-5402	KTH-2105		24
125-61-9		Plug, Crimp, W/P	M	Nickel	1.250	0.640				CP-402	KTH-2081		24
KA-59-375 M07		Plug, Crimp, W/P	M	Silver	1.110	0.630				CP-465	KTH-2120		24
KA-59-392 M06		Plug, Crimp, W/P	M	Nickel	1.140	0.630				CP-5401	KTH-2128		24
KA-59-188		Plug, Crimp, W/P	M	Nickel	1.100	0.630			45	CP-5401	KTH-2161		24

Plug - K-Grip, JR.

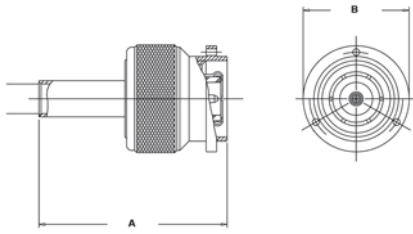

Figure 25

Termination

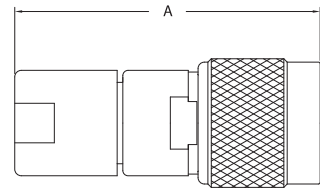

Figure 26

Angle Receptacle

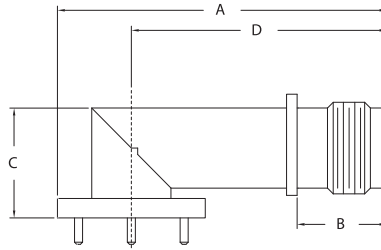

Figure 27

Item Number	Military PN	Product Description	Gender	Finish	Dimensions				Cable Group	Cable Procedure	Crimp Die	Mounting Hole	Figure #
					A	B	C	D					
KA-59-290	M39012/26-0501	Plug, Crimp	M	Silver	1.110	0.630			C1	CP-465	KTH-2007		25
125-19-5	M39012/26-0022	Plug, Crimp	M	Silver	1.460	0.640			B1	CP-465	KTH-2011		25
KA-59-69		Plug, Crimp	M	Silver	0.940	0.590			B1	CP-406	KTH-2032		25
KA-59-291	M39012/26-0502	Plug, Crimp	M	Silver	1.110	0.630			C2	CP-465	KTH-2007		25
KA-59-103		Plug, Crimp	M	Nickel	1.100	0.590			D	CP-401	KTH-2001		25
KA-59-220		Plug, Crimp, Polarized	M	Nickel	1.080	0.590			D	CP-401	KTH-2001		25
KA-59-406 M06		Plug, Crimp	M	Nickel	1.100	0.590			D	CP-401	KTH-2001		25
KA-59-231	M39012/26-0010	Plug, Crimp	M	Silver	1.080	0.630			D	CP-465	KTH-2001		25
KA-59-287	M39012/26-0504	Plug, Crimp	M	Silver	1.110	0.630			D	CP-465	KTH-2001		25
125-114-5		Plug, Crimp	M	Silver	1.180	0.640			E1	CP-465	KTH-2001		25
KA-59-230	M39012/26-0011	Plug, Crimp	M	Silver	1.080	0.630			E1	CP-465	KTH-2001		25
KA-59-263		Plug, Crimp	M	Nickel	1.080	0.630			E1	CP-465	KTH-2001		25
KA-59-292	M39012/26-0503	Plug, Crimp	M	Silver	1.110	0.630			E1	CP-465	KTH-2001		25
KA-59-232	M39012/26-0012	Plug, Crimp	M	Silver	1.060	0.630			G1	CP-465	KTH-2002		25
KA-59-279	M39012/26-0021	Plug, Crimp	M	Silver	1.080	0.630			H	CP-465	KTH-2002		25
125-80-9		Plug, Crimp	M	Nickel	1.090	0.590				3-491	KTH-2002		25
128-30-9		Plug, Crimp, W/O Pin	M	Nickel	0.930	0.590				3-491	KTH-2002		25
125-103-5		Plug, Crimp	M	Silver	2.030	0.640				CP-5402	KTH-2012		25
125-104-5		Plug, Crimp	M	Silver	2.030	0.640				CP-5402	KTH-2012		25
KA-89-15		Termination	M	Nickel	1.420								26
127-26-9		Receptacle, PCB, Angle	F	Nickel	1.520	N/A	0.520	0.990					N/S
2437-4-5		Receptacle, PCB, Angle	F	Nickel	1.520	0.431	0.520	1.180					27

Bulkhead Receptacles

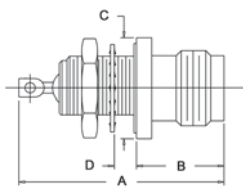

Figure 28

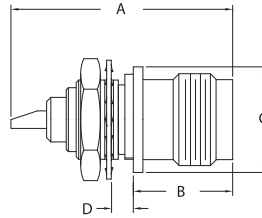

Figure 29

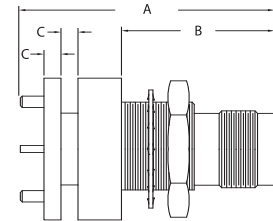

Figure 30

Panel Receptacles

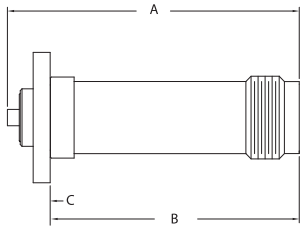

Figure 31

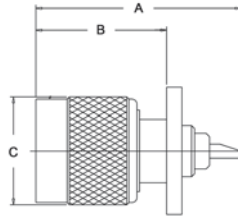

Figure 32

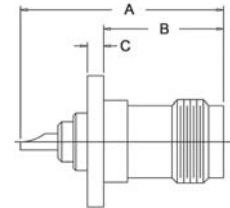

Figure 33

Item Number	Military PN	Product Description	Gender	Finish	Dimensions				Cable Group	Cable Procedure	Crimp Die	Mounting Hole	Figure #
					A	B	C	D					
KA-71-04	M39012/34-0002	Receptacle, Bulkhd, Hermetic	F	Silver	1.210	0.520	0.590	0.273				H	28
KA-79-28		Receptacle, Bulkhead	F	Nickel	1.060	0.470	0.500	0.132				H	29
KA-79-56		Receptacle, Bulkhead	M	Nickel	1.190	0.670	0.590					H	N/S
KA-79-59		Receptacle, Iso Ground, Bulkhead	F	Nickel	1.060	0.520	0.560	0.174				X	29
KA-71-02	M39012/31-0001	Receptacle, Bulkhd	F	Silver	1.050	0.480	0.500	0.135				AB	29
KA-71-08	M39012/31-0002	Receptacle, Bulkhd	F	Silver	1.190	0.470	0.500	0.260				H	29
KA-71-03	M39012/34-0001	Receptacle, Bulkhd, Hermetic	F	Silver	1.210	0.830	0.680					X	N/S
KA-79-165 M06		Receptacle, PCB, Bulkhd	F	Nickel	1.450	0.810	0.090	0.090				X	30
127-15		Receptacle, Panel	F	Nickel	1.560	1.300	0.090					*	31
127-19-9		Receptacle, Panel	F	Nickel	1.540	1.310	0.090					*	31
127-20-9		Receptacle, Panel	F	Nickel	1.600	1.310	0.090					*	31
KA-79-161 MC9		Receptacle, Panel, Hermetic	F	Gold	0.830	0.530							31
2437-2-0		Receptacle, Panel	F	Nickel	1.590	1.530	0.110					*	31
KA-71-09		Receptacle, Panel	M	Silver	1.170	0.750	0.590					*	32
KA-79-157 M06		Receptacle, Panel	M	Nickel	1.170	0.750	0.090					*	32
KA-79-118		Receptacle, Panel	F	Nickel	1.060	0.620	0.090					*	33
KA-79-156 M06		Receptacle, Panel	F	Nickel	0.860	0.430	0.090					*	33
KA-79-39	M39012/32-0001	Receptacle, Panel	F	Silver	1.060	0.620	0.090					*	33
K-4944		Body Assembly	M	Nickel	1.080	0.480			E1	CP-5401	KTH-2061		N/S

*Please Contact Customer Service for Additional Information

ADAPTERS - WITHIN SERIES

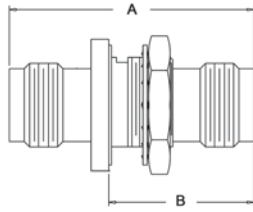

Figure 34

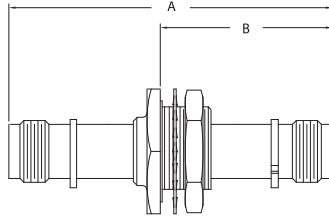

Figure 35

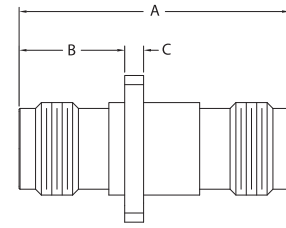

Figure 36

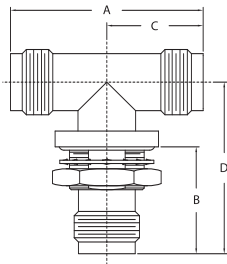

Figure 37

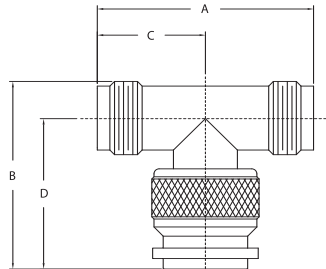

Figure 38

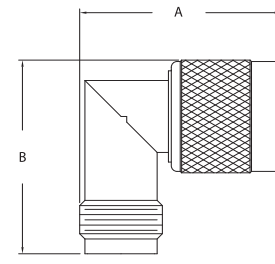

Figure 39

Item Number	Military PN	Product Description	Gender	Finish	Dimensions				Cable Group	Cable Procedure	Crimp Die	Mounting Hole	Figure #
					A	B	C	D					
KA-99-56		Within Series Adapter, Bulkhd, Hermetic	F-F	Nickel	1.390	0.730						X	34
KA-91-02		Within Series Adapter, Bulkhd, Hermetic	F-F	Silver	1.390	0.730						X	34
KA-99-79		Within Series Adapter, Bulkhd, Iso Grd	F-F	Silver	1.280	0.430	0.630	0.440				X	34
129-26-9		Within Series Adapter, Bulkhd	F-F	Nickel	1.280	0.812						*	34
KA-99-114 M06		Within Series Adapter, Bulkhd	F-F	Nickel	1.280	0.730						X	34
129-29-9		Within Series Adapter, Bulkhd	F-F	Nickel	1.281	0.760						X	34
2439-5-1		W/I Series Adapt, Bulkhd, Hermetic, Keyed	F-F	Nickel	2.290	1.210						I	35
2439-5-16		W/I Series Adapt, Bulkhd, Hermetic, Keyed	F-F	Nickel	2.290	0.890						I	35
2439-5-6		W/I Series Adapt, Bulkhd, Hermetic, Keyed	F-F	Nickel	2.290	1.210						I	35
2439-6-1		W/I Series Adapt, Bulkhd, Hermetic, Keyed	F-F	Nickel	2.500	1.410						I	35
2439-5-9		W/I Series Adapt, Bulkhd, Hermetic, Keyed	F-F	Nickel	2.290	1.210						X	35
2439-6-6		W/I Series Adapt, Bulkhd, Hermetic, Keyed	F-F	Nickel	2.500	1.410						I	35
2439-6-9		W/I Series Adapt, Bulkhd, Hermetic, Keyed	F-F	Nickel	2.500	1.410						I	35
129-23-9		Within Series Adapter, Panel	F-F	Nickel	1.280	0.500	0.090					*	36
2439-1-1		Within Series Adapter, Panel, Keyed	F-F	Nickel	1.870	0.930	0.090					*	N/S
2439-1-11		Within Series Adapter, Panel, Keyed	F-F	Nickel	1.870	0.930	0.090					*	N/S
2439-1-16		Within Series Adapter, Panel, Keyed	F-F	Nickel	1.870	0.930	0.090					*	N/S
2439-1-6		Within Series Adapter, Panel, Keyed	F-F	Nickel	1.870	0.930	0.090					*	N/S
KA-99-74		Within Series Adapter, Panel	F-F	Nickel	1.280	0.496	0.090					*	36
129-6	M55339/50-00001	Within Series Adapter, Bulkhd, Tee	F-F-F	Silver	1.280	0.710	0.440	1.140				X	37
129-6 M06		Within Series Adapter, Bulkhd, Tee	F-F-F	Nickel	1.280	0.710	0.440	1.140				X	37
129-4	M55339/35-00001	Within Series Adapter, Tee	F-M-F	Silver	1.280	1.110	0.630	0.890					38
KA-91-16		Within Series Adapter, Tee	F-M-F	Silver	1.280	1.110	0.640	0.890					38
KA-99-125 M06		Within Series Adapter, Tee	F-M-F	Nickel	1.280	1.110	0.630	0.890					38
KA-99-98		Within Series Adapter, Tee	M-F-F	Silver	1.530	1.060	0.640	0.760					N/S
KA-91-15		Within Series Adapter, Angle	M-F	Silver	1.060	1.020							39
KA-99-65		Within Series Adapter, Angle	M-F	Nickel	1.040	1.060							39

* Please Contact Customer Service for Additional Information

Accessories

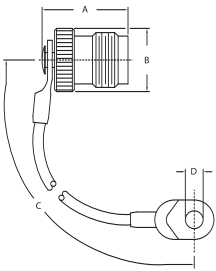

Figure 40

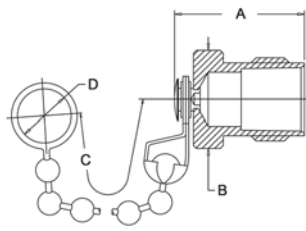

Figure 41

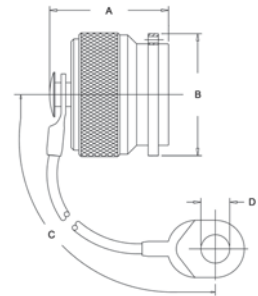

Figure 42

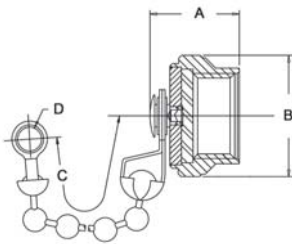

Figure 43

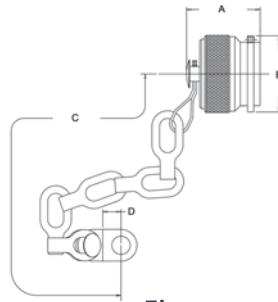

Figure 44

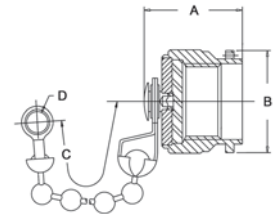

Figure 45

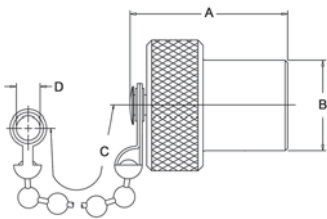

Figure 46

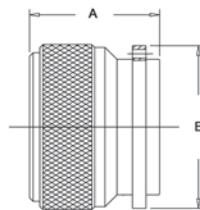

Figure 47

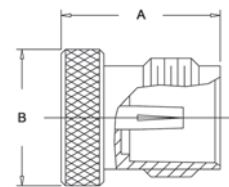

Figure 48

Item Number	Military PN	Product Description	Gender	Finish	Dimensions				Cable Group	Cable Procedure	Crimp Die	Mounting Hole	Figure #
					A	B	C	D					
128-17-5		Dust Cap & Rope	F	Silver	0.680	0.500	7.000	0.140					40
128-26-5	M39012/25-0118	Dust Cap & Rope	F	Silver	0.680	0.500	4.000	0.140					40
128-32-9		Dust Cap & Chain	F	Nickel	0.680	0.500	3.250	0.280					41
KA-81-02	M39012/25-0018	Dust Cap & Chain	F	Silver	0.680	0.500	3.000	0.280					41
KA-81-07		Dust Cap & Chain	F	Silver	0.690	0.500	3.730	0.440					41
128-25-5	M39012/25-0120	Dust Cap & Rope	M	Silver	0.710	0.650	4.000	0.140					42
128-31-5		Dust Cap & Chain	M	Silver	0.500	0.630	2.250	0.140					43
128-33-5		Dust Cap & Chain	M	Silver	0.718	0.650	2.500						44
KA-89-82	M39012/25-0021	Dust Cap & Chain	M	Silver	0.718	0.650	0.030	2.700					44
KA-81-05		Dust Cap & Chain	M	Silver	0.550	0.600	2.250	0.140					45
KA-89-18		Dust Cap & Chain	M	Nickel	0.580	0.650	0.144	2.250					45
KA-81-01	M39012/25-0020	Dust Cap & Chain	M	Silver	0.580	0.630	2.250	0.140					45
128-3-5		Dust Cap & Chain	M	Silver	0.950	0.550	2.250						46
KA-81-04		Dust Cap	M	Silver	0.480	0.630							47
KA-81-04 M06		Dust Cap & Chain	M	Nickel	0.480	0.630							47
KA-81-03		Shorting Cap	F	Silver	0.580	0.500							48